

REM 1

REM 1SQ

User Manual

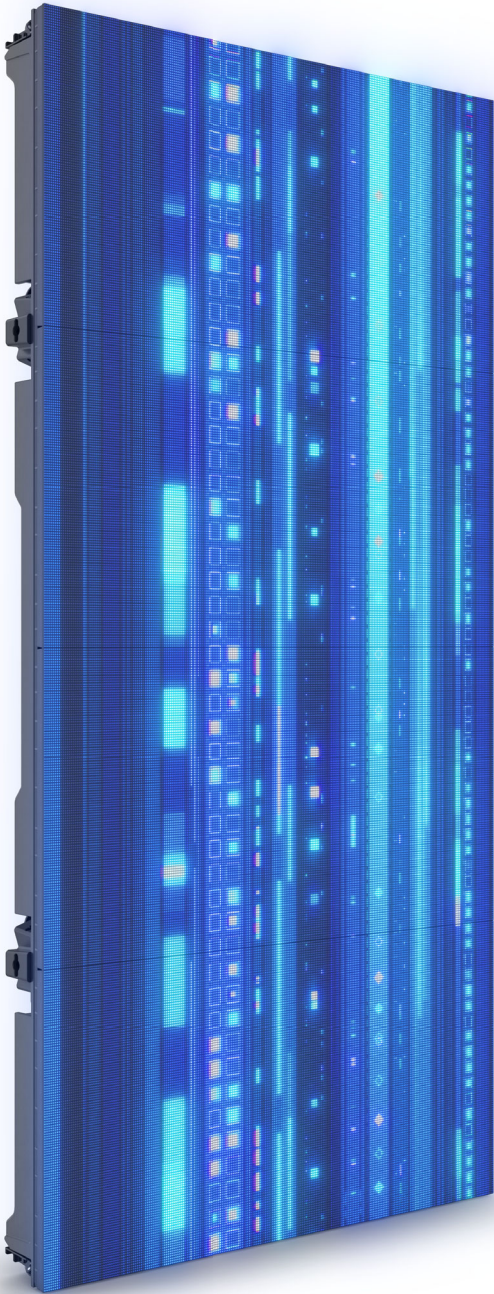

Model ID: REM1

Model ID: REM1SQ

CHAUVET
PROFESSIONAL

Edition Notes

The REM 1 and REM 1SQ User Manual includes a description, safety precautions, installation, programming, operation and maintenance instructions for the REM 1 and REM 1SQ as of the release date of this edition.

Trademarks

Chauvet, the Chauvet logo, and REM are registered trademarks or trademarks of Chauvet & Sons, LLC (d/b/a Chauvet and Chauvet Lighting) in the United States and other countries. Other company and product names and logos referred to herein may be trademarks of their respective companies.

Copyright Notice

The works of authorship contained in this manual, including, but not limited to, all designs, text, and images are owned by Chauvet.

© **Copyright 2024 Chauvet & Sons, LLC. All rights reserved.**

Electronically published by Chauvet in the United States of America.

Manual Use

Chauvet authorizes its customers to download and print this manual for professional information purposes only. Chauvet expressly prohibits the usage, copy, storage, distribution, modification, or printing of this manual or its content for any other purpose without written consent from Chauvet.

Document Printing

For best results, print this document in color, on letter size paper (8.5 x 11 in), double-sided. If using A4 paper (210 x 297 mm), configure the printer to scale the content accordingly.

Intended Audience

Any person installing, operating, and/or maintaining this product should completely read through the guide that shipped with the product, as well as this manual, before installing, operating, or maintaining this product.

Disclaimer

Chauvet believes that the information contained in this manual is accurate in all respects. However, Chauvet assumes no responsibility and specifically disclaims any and all liability to any party for any loss, damage or disruption caused by any errors or omissions in this document, whether such errors or omissions result from negligence, accident or any other cause. Chauvet reserves the right to revise the content of this document without any obligation to notify any person or company of such revision, however, Chauvet has no obligation to make, and does not commit to make, any such revisions.

Document Revision

Go to www.chauvetprofessional.com for the latest version.

| Revision | Date | Description |
|----------|---------|--|
| 3 | 08/2024 | Updated safety/mounting section to include vertical mounting note. |

TABLE OF CONTENTS

| | |
|---|-----------|
| 1. Before You Begin | 1 |
| What Is Included | 1 |
| Claims..... | 1 |
| Text Conventions..... | 1 |
| Symbols..... | 1 |
| Safety Notes | 2 |
| FCC Statement of Compliance | 3 |
| Expected LED Lifespan | 3 |
| 2. Introduction | 4 |
| Product Description | 4 |
| Features..... | 4 |
| Required Accessories..... | 4 |
| Optional Accessories | 4 |
| Available Power Cables..... | 4 |
| Product Overview | 5 |
| Pixels per Panel..... | 6 |
| REM 1 and REM 1SQ LED Module Insertion and Removal..... | 7 |
| Removing a Module from the Rear..... | 7 |
| Inserting a Module | 8 |
| Removing and Replacing the LED Masks | 9 |
| Scrambled Pulse-Width Modulation | 9 |
| Product Dimensions | 10 |
| 3. Setup | 11 |
| AC Power | 11 |
| AC Plug..... | 11 |
| Power Linking | 11 |
| 4. Mounting | 12 |
| Orientation | 12 |
| Mounting Points..... | 12 |
| REM-RB 50CMIP CURVE Dual Function Rig Bar Dimensions..... | 13 |
| REM-RB 100CMIP Dual Function Rig Bar Dimensions | 13 |
| Mounting/hanging with Dual Function Rig Bar | 14 |
| Curving the Panels | 15 |
| Adjusting the Height | 15 |
| Truss Installation..... | 16 |
| Mounting/Stacking with Dual Function Rig Bar | 17 |
| Removing the Feet | 17 |
| Flat Wall Installation | 18 |
| Mounting Points on a Flat Wall | 18 |
| Mounting with Steel Struts | 18 |
| Flat Wall Installation..... | 19 |
| Safety Cable Installation | 20 |

| | |
|--|-----------|
| 5. Joining Each REM 1 and REM 1SQ | 21 |
| Vertically Joining the Panels..... | 21 |
| Vertical Panel Connection | 22 |
| Horizontally Joining the Panels | 23 |
| Horizontal Panel Connection | 23 |
| 6. Connecting & Cabling Each REM 1 and REM 1SQ..... | 24 |
| Testing Signal and Power Connections..... | 24 |
| Using the REM 1 and REM 1SQ Test Button | 24 |
| Connecting Power and Signal Cables | 25 |
| Connecting the Signal Between Joined Panels | 25 |
| Signal Chain Rectangles | 26 |
| Connecting the Power Between Joined Panels..... | 27 |
| 7. LED Module Care and Replacement..... | 28 |
| REM 1 and REM 1SQ Modules..... | 28 |
| Module Description | 28 |
| Calibration Recall..... | 28 |
| 8. REM 1 and REM 1SQ Serviceability..... | 29 |
| 9. Typical REM 1 and REM 1SQ Hanging installation | 30 |
| 10. Operation | 31 |
| Additional Hardware and Software | 31 |
| About Nova VMP | 31 |
| Description..... | 31 |
| Receiver Card Configuration Files..... | 31 |
| Operating Nova VMP..... | 32 |
| Selecting a Processor..... | 32 |
| Selecting a Signal Source..... | 33 |
| Customizing the Canvas..... | 34 |
| Mapping Video Panels..... | 36 |
| Changing the Video Panel Orientation | 38 |
| Rotating the Video Panel Orientation | 39 |
| Updating Cabinet Firmware | 40 |
| Updating Controller Firmware..... | 41 |
| 11. Technical Information | 42 |
| REM 1 and REM 1SQ Maintenance..... | 42 |
| 12. Technical Specifications | 43 |
| Contact Us | 45 |
| Warranty & Returns | 45 |

Before You Begin

1. Before You Begin

What Is Included

REM1

- 1 case (4 REM1)
- 1 Seetronic® PowerKON® power cable
- 4 Seetronic® PowerKON® power linking cables
- 4 Seetronic® etherKON® signal linking cables
- 5 spare LED masks
- User manual

REM1SQ

- 1 case (8 REM1SQ)
- 1 Seetronic® PowerKON® power cable
- 8 Seetronic® PowerKON® power linking cables
- 8 Seetronic® etherKON® signal linking cables
- 5 spare LED masks
- User manual

Claims

Carefully unpack the product immediately and check the container to make sure all the parts are in the package and are in good condition.





If the box or the contents (the product and included accessories) appear damaged from shipping, or show signs of mishandling, notify the carrier immediately, not Chauvet. Failure to report damage to the carrier immediately may invalidate a claim. In addition, keep the box and contents for inspection.

For other issues, such as missing components or parts, damage not related to shipping, or concealed damage, file a claim with Chauvet within 7 days of delivery.

Text Conventions

| Convention | Meaning |
|---------------------------|--|
| 1–512 | A range of values |
| 50/60 | A set of values of which only one can be chosen |
| Settings | A menu option not to be modified |
| Menu > Settings | A sequence of menu options to be followed |
| <ENTER> | A key to be pressed on the product's control panel |

Symbols

| Symbol | Meaning |
|---|---|
|  | Critical installation, configuration, or operation information. Not following these instructions may make the product not work, cause damage to the product, or cause harm to the operator. |
|  | Important installation or configuration information. The product may not function correctly if this information is not used. |
|  | Useful information. |
|  | Pinch point warning. |

Safety Notes

Read all the following safety notes before working with this product. These notes contain important information about the installation, usage, and maintenance of this product.



This product contains no user-serviceable parts. Any reference to servicing in this User Manual will only apply to properly trained, certified technicians. Do not open the housing or attempt any repairs.



All applicable local codes and regulations apply to proper installation of this product.

- **CAUTION:**

- This product's housing may be hot when operating. Mount this product in a location with adequate ventilation, at least 20 in (50 cm) from adjacent surfaces.
- When transferring the product from extreme temperature environments, (e.g., cold truck to warm humid ballroom) condensation may form on the internal electronics of the product. To avoid causing a failure, allow the product to fully acclimate to the surrounding environment before connecting it to power.

- **ALWAYS:**

- Use a safety cable when mounting this product overhead.
- Connect this product to a grounded and protected circuit.

- **DO NOT:**

- Open this product. It contains no user-serviceable parts.
- Leave any flammable material within 50 cm of this product while operating or connected to power.
- Connect this product to a dimmer or rheostat.
- Operate this product if the housing, lenses, or cables appear damaged.
- Operate this product outdoors or in any location where dust, excessive heat, water, or humidity may affect it (IP30).
- Operate this product at an altitude exceeding 5000m.
- ONLY use the hanging/mounting bracket to carry this product.
- ONLY mount this product in a vertical orientation as shown in this manual. Mounting in other ways may result in serious injury.
- The minimum startup temperature is -4°F (-20°C). Do not start the product at lower temperatures.
- The maximum ambient temperature is 95°F (35 °C). Do not operate this product at higher temperatures.
- To eliminate unnecessary wear and improve its lifespan, during periods of non-use completely disconnect the product from power via breaker or by unplugging it.
- In the event of a serious operating problem, stop using immediately.



If this Chauvet product requires service, contact Chauvet Technical Support.

Before You Begin

FCC Statement of Compliance

This device complies with Part 15 Part B of the FCC rules. Operation is subject to the following two conditions:

1. This device may not cause harmful interference, and
2. This device must accept any interference received, including interference that may cause undesired operation.

This equipment has been tested and found to comply with the limits for a Class B digital device, pursuant to Part 15 of the FCC Rules. These limits are designed to provide reasonable protection against harmful interference in a residential installation. This equipment generates uses and can radiate radio frequency energy and, if not installed and used in accordance with the instructions, may cause harmful interference to radio communications. However, there is no guarantee that interference will not occur in a particular installation. If this equipment does cause harmful interference to radio or television reception, which can be determined by turning the equipment off and on, the user is encouraged to try to correct the interference by one or more of the following measures:

- Reorient or relocate the receiving antenna.
- Increase the separation between the equipment and receiver.
- Connect the equipment into an outlet on a circuit different from that to which the receiver is connected.
- Consult the dealer or an experienced radio/TV technician for help.

Any changes or modifications not expressly approved by the party responsible for compliance could void the user's authority to operate the equipment.



The use of certain substances in electrical and electronic equipment is restricted with the EU. For further information, see directive 2011/65/EU.

Expected LED Lifespan

Over time, use and heat will gradually reduce LED brightness. Clustered LEDs produce more heat than single LEDs, contributing to shorter lifespans if always used at full intensity. The average LED lifespan is 40,000 to 50,000 hours. To extend LED lifespan, maintain proper ventilation around the product, and limit the overall intensity.

2. Introduction

Product Description

REM 1 is a high-resolution 800 NITS indoor video wall solution with a 1.9mm pitch, integrated convex/concave curving capabilities, and universal magnetic LED modules. Its DCI-P3 color gamut LEDs offer 26% more color possibilities compared to standard sRGB/Rec.709 LEDs. With high-speed 7680Hz LED drivers, A10s Pro Novastar Receiving cards, and low latency, REM 1 offers top-tier performance and signal processing for VR/XR applications, exhibits, houses of worship, installations and indoor events.

Features

- 1.9 mm pitch, ultra-high resolution, modular, indoor video panel
- Map and scale your wall with the Novastar MX40 Pro sender
- Universal, magnetic LED modules for easy replacement and servicing
- Magnetic-assisted hanging integrated into frames makes building a screen fast and easy with minimal labor/effort required
- Offered in two physical sizes: 1 m x 0.5 m (REM1SQ), 0.5 x 0.5 m (special order REM1SQ)
- Integrated curving capabilities for concave and convex configurations
- Spring-loaded corner protection for safe transportation and handling
- Operating in the DCI-P3 color space and driven via the premium A10s Pro receiver card from Novastar, black body LEDs accurately reproduce video at 22-bit+ grayscale and a wide color gamut
- High performance LED drivers deliver 3,840 Hz refresh rate for camera-friendly operation in high-demand applications
- Low latency
- and HDR10 supported for VR/XR studio, live applications
- Design allows for overhead hanging, ground stacking, and wall mounting, maximized for multiple applications
- Specialized anti-reflective coating applied to the front of LED modules ensures optimal viewing comfort
- Ground support/stacking system available in scalable road case-GROUNDSUPPORT2KIT

Required Accessories

- Required Software: NovaVMP
- Controller (required): Novastar MX40 Pro
- Compatible Mounting Options: REM Rig Bar (0.5 m, 1 m lengths offered,) M10 Bolt/Clamp (rear or surface mounting), GROUNDSTACKKIT (floor mounting/Stacking)

Optional Accessories

- Clamps
- Seetronic powerKON cables
- REM-RB100CMIP
- REM-RB50CMIP-CURVE
- GROUNDSTACKKIT
- MT07 Universal Module Removal Tool

Available Power Cables

Power cables (Seetronic® PowerKON Power Extensions)

- IP65 Rated Seetronic® PowerKON Extension,
 - 5 ft
 - 10 ft
 - 25 ft

Product Overview

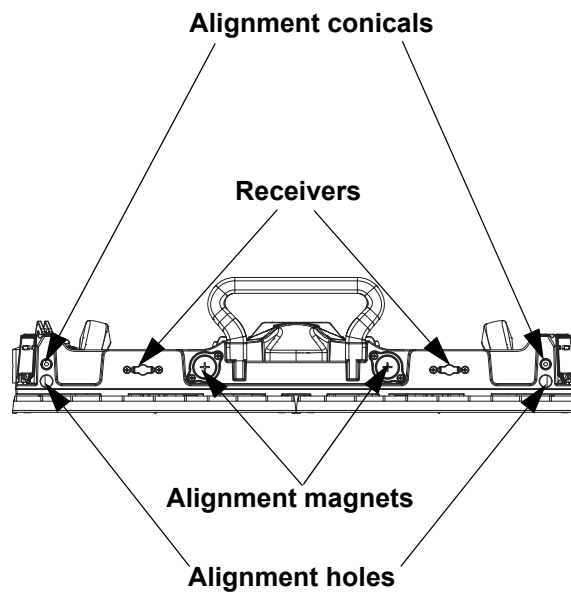
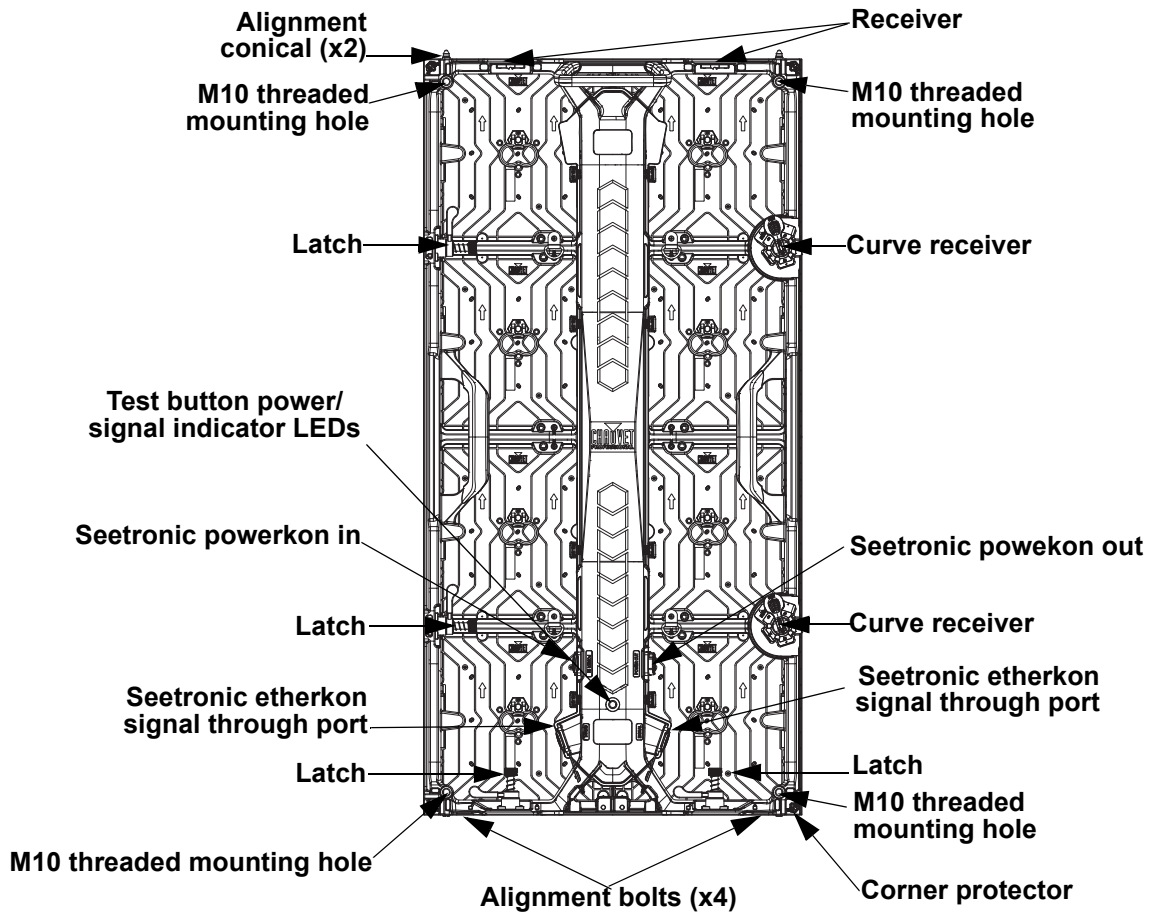

Pixels per Panel

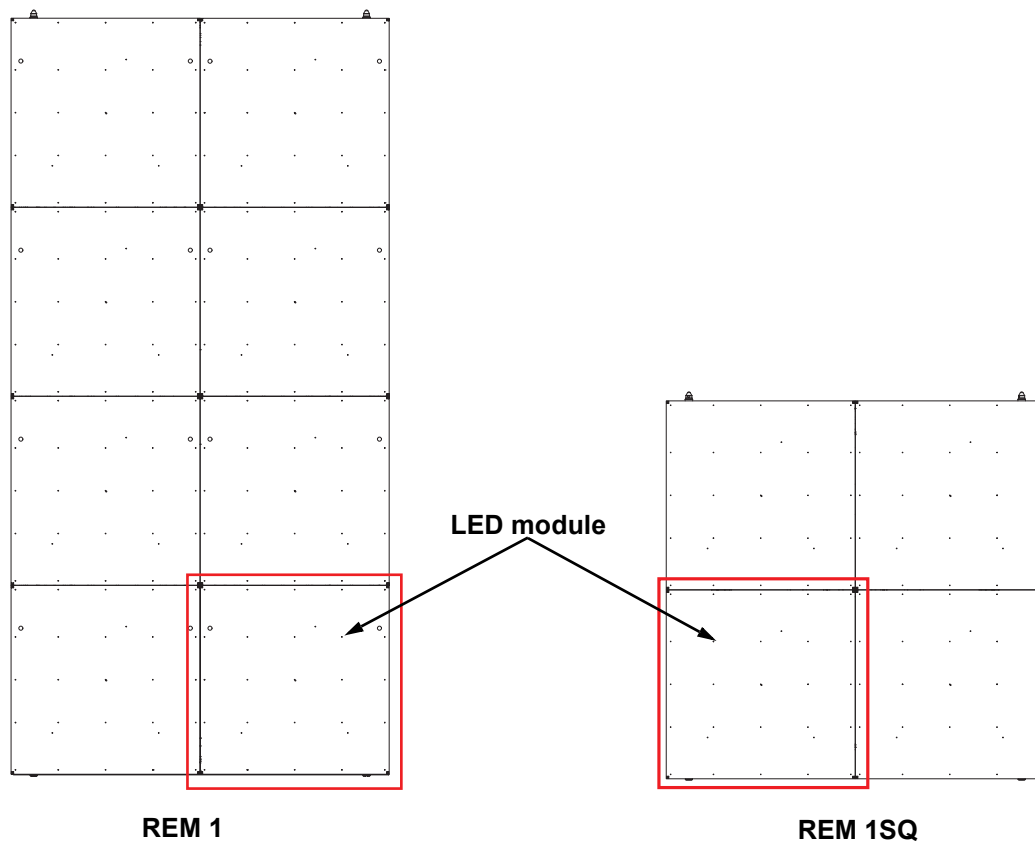

Each pixel is 1 tri-color LED. The following table provides the pixels per panel in each REM 1 and REM 1SQ. For detailed specifications, refer to the [Technical Specifications](#) table at the end of this User Manual.

| Parameter | REM 1 | REM 1SQ |
|------------------------------------|--------------|--------------|
| Total Pixels per Panel | 131,072 | 65,536 |
| Total Pixels per LED Module | 16,384 | 16,384 |
| LED Module Dimensions | 250 x 250 mm | 250 x 250 mm |

REM 1 and REM 1SQ LED Module Insertion and Removal

Removing a Module from the Rear

To remove an LED module from the rear of the REM 1 and REM 1SQ:

1. Identify which module needs to be removed.
2. Carefully grip the module by the handles from the rear of the panel assembly.

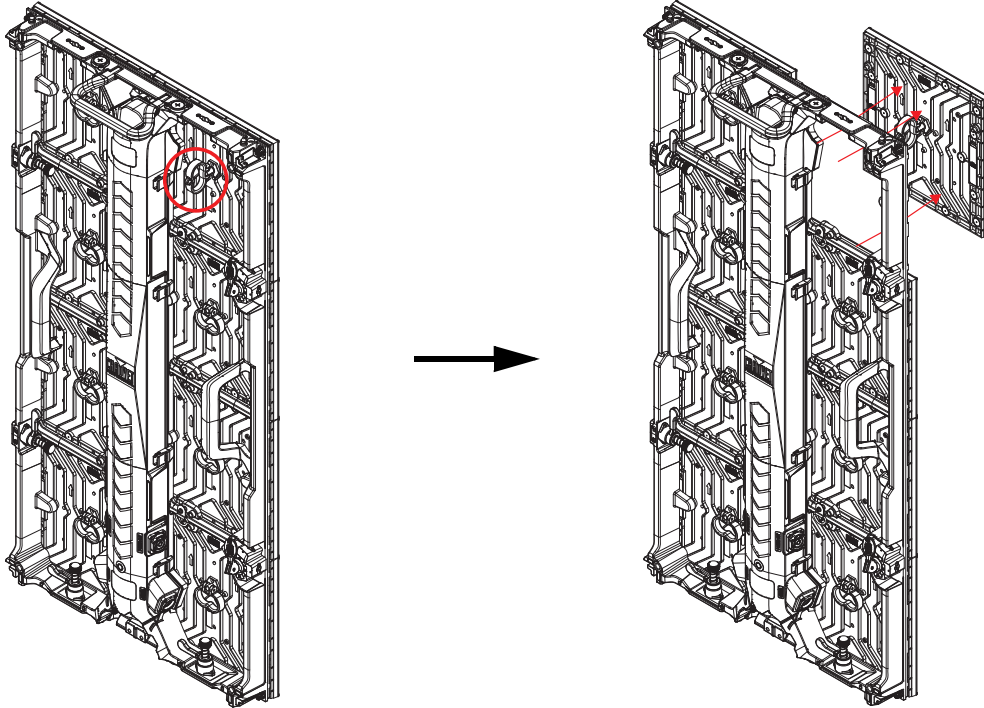

3. With steadily increasing force and keeping as straight as possible, push the module forward away from the frame until it comes loose.



Use caution when removing the module so as not to damage the connector attached to the back of the module.



Modules are universal and will fit anywhere on the frame.

4. Carefully tilt the module to pull it through to the rear, or have someone on the other side take it.
5. Reverse the steps to install the replacement module.



WARNING! The magnets on the modules are very powerful! Keep fingers clear when installing.

Inserting a Module

1. In order to insert a module onto the panel, simply reverse the steps outlined in [Removing a Module from the Rear](#).
2. If the module is placed on the right side of the panel, place the connector cover on the right side connector.

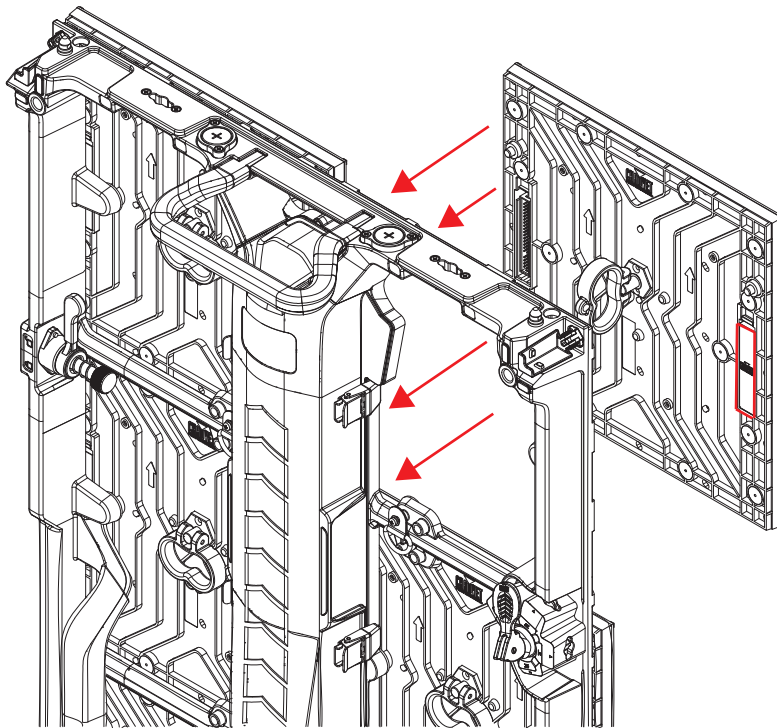

3. If the module is placed on the left side of the panel, place the connector cover on the left side connector.

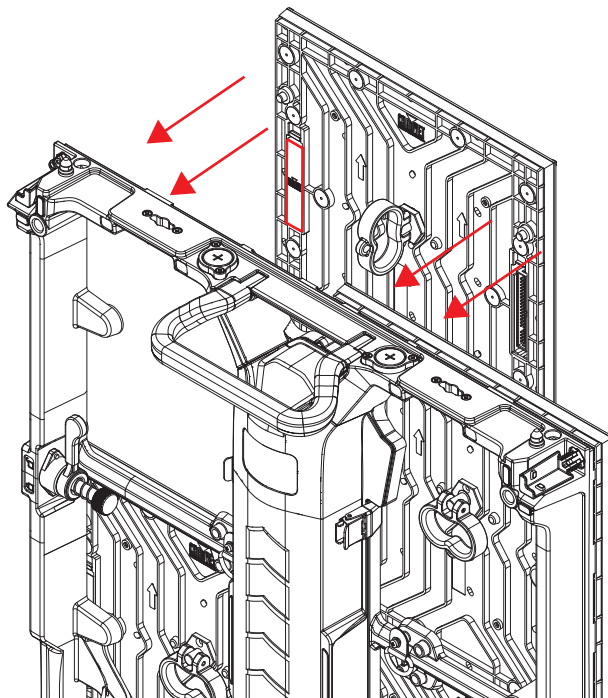

For more information about module care, [LED Module Care and Replacement](#).

Removing and Replacing the LED Masks

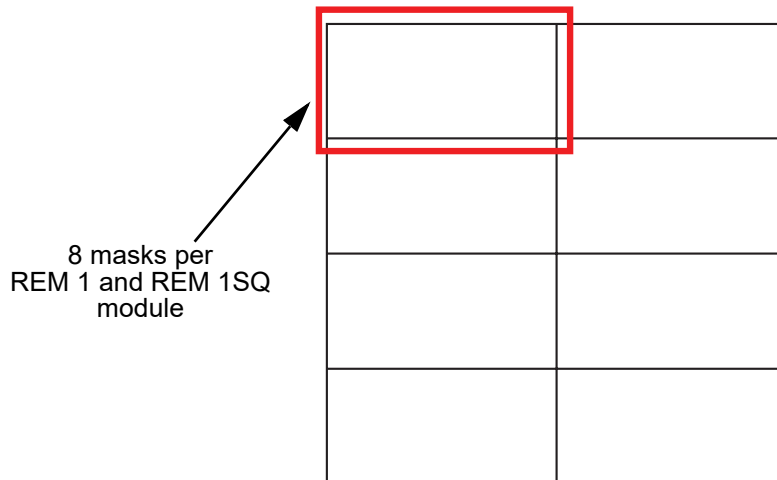

To replace one of the LED masks on an REM 1 and REM 1SQ LED module, follow the instructions below:

1. Remove the module from the REM 1 and REM 1SQ (see [REM 1 and REM 1SQ LED Module Insertion and Removal](#)).
2. Using a fingertip, gently lift the edges of the mask off of the LEDs.

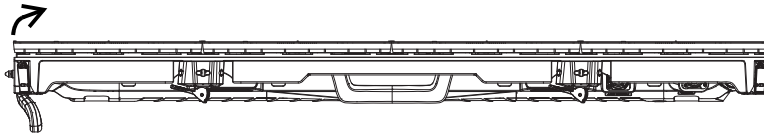

- Use a roller tool to gently press the masks onto the LEDs.
- Bending the mask too much will permanently stretch it beyond usability.



- Take **SPECIAL CARE** to not pry off any LEDs!
- **DO NOT** use prying tool to remove the LED mask! Doing so may damage the LEDs.
- **When in doubt, seek expert assistance or advice!**

3. Once the edges are loose, slowly lift the mask from the LEDs.
4. Place the new LED mask in the space, with the rear (arrows) side facing in towards the product. Ensure the orientation arrows point in the same direction as the arrows on the module.
5. Push the mask in firmly until it is completely flush with the rest of the masks on the product. A roller tool is recommended for this procedure.

Scrambled Pulse-Width Modulation

This product features Scrambled-PWM (S-PWM) technology, which de-synchronizes the pulse widths of each color of the multi-color LEDs. This ensures that there is always some LED output, reducing flicker, and maintaining the same grayscale performance.

Product Dimensions

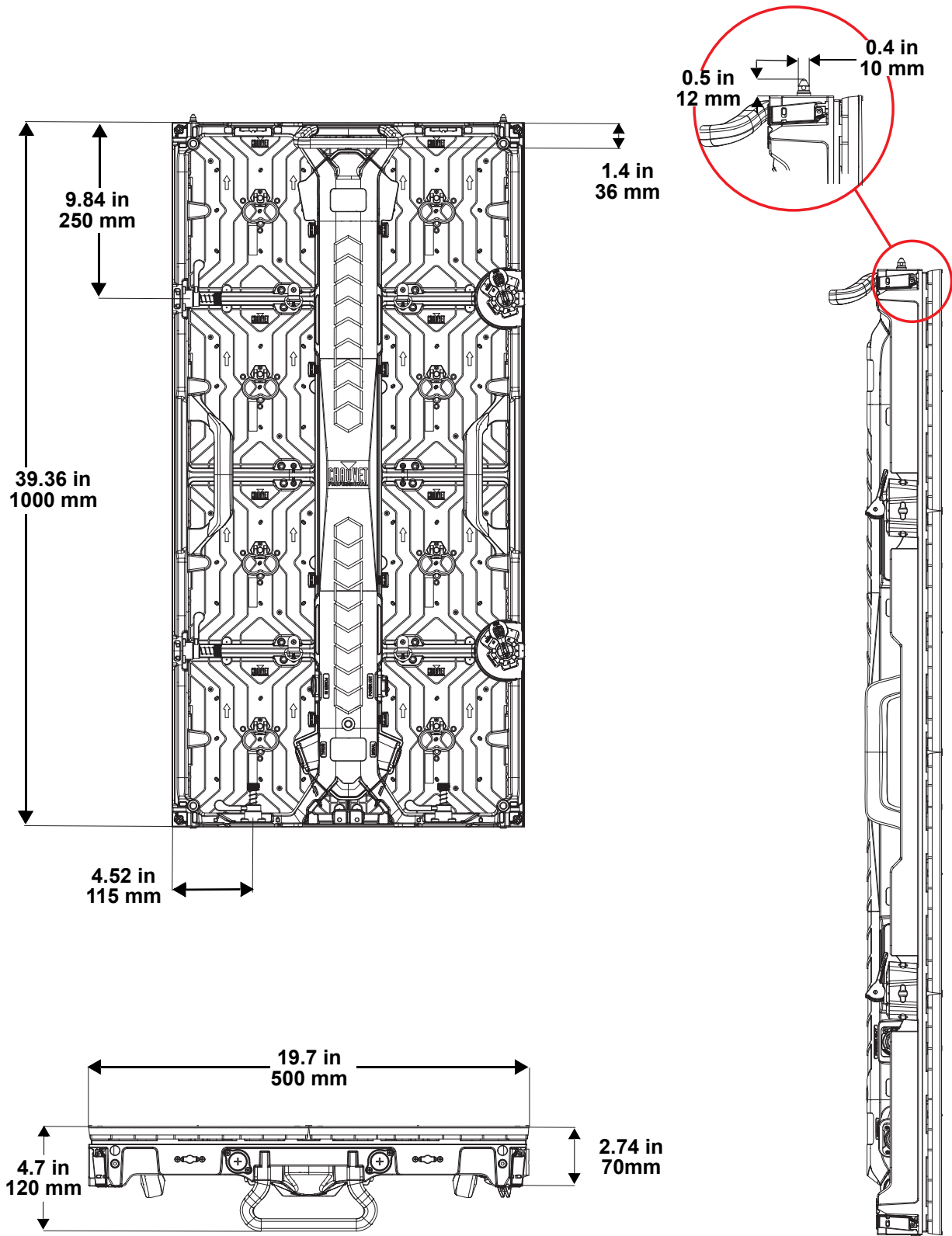

Setup

3. Setup

AC Power

The REM 1 and REM 1SQ has an auto-ranging power supply and can work with an input voltage range of 100 to 240 VAC, 50/60 Hz.

To determine the product's power requirements (circuit breaker, power outlet, and wiring), use the current value listed on the label affixed to the product's back panel, or refer to the product's specifications chart. The listed current rating indicates the product's average current draw under normal conditions.



- **Always connect the product to a protected circuit (a circuit breaker or fuse). Make sure the product has an appropriate electrical ground to avoid the risk of electrocution or fire.**
- **To eliminate unnecessary wear and improve its lifespan, during periods of non-use completely disconnect the product from power via breaker or by unplugging it.**



Never connect the product to a rheostat (variable resistor) or dimmer circuit, even if the rheostat or dimmer channel serves only as a 0 to 100% switch.

AC Plug

The REM 1 and REM 1SQ come with a power input cord terminated with a Seetronic Powerkon A connector on one end and an Edison plug on the other end (U.S. market). If the power input cord that came with the product has no plug, or if it is necessary to change the plug, use the table below to wire the new plug.

| Connection | Wire (U.S.) | Wire (Europe) | Screw Color |
|------------|--------------|---------------|-----------------|
| AC Live | Black | Brown | Yellow or Brass |
| AC Neutral | White | Blue | Silver |
| AC Ground | Green/Yellow | Green/Yellow | Green |

Power Linking

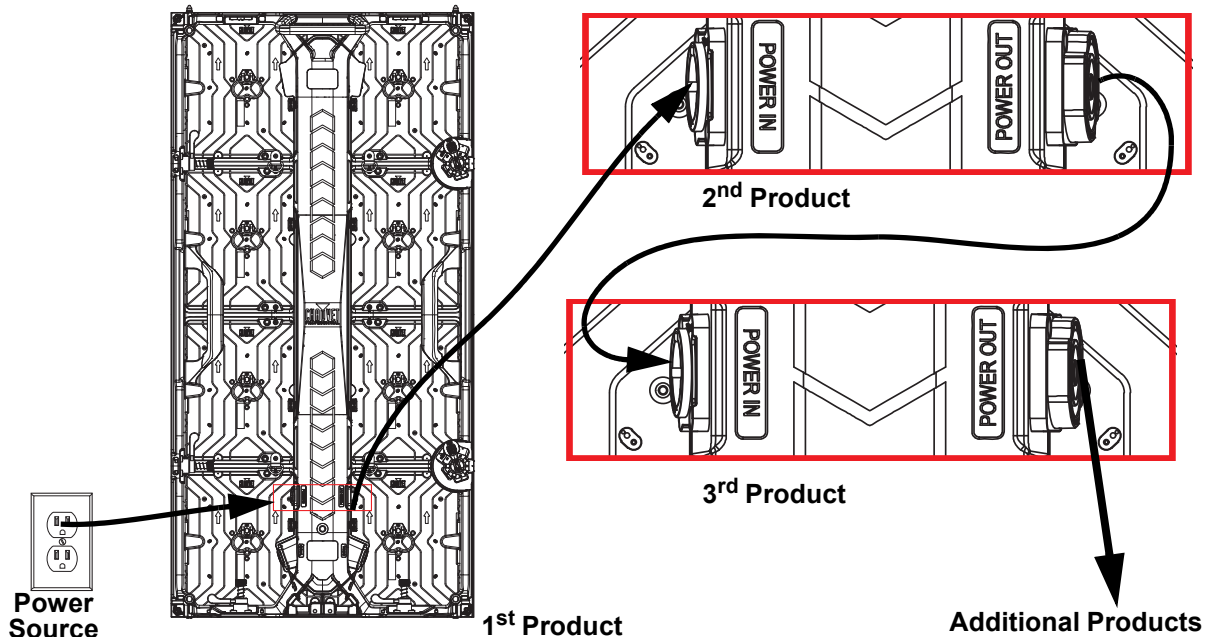

All REM 1 and REM 1SQ panels support power linking. Refer to the following table for specifications.

| Voltage | REM1 | REM 1SQ |
|----------------|------|---------|
| @ 120 V, 60 Hz | 7 | 15 |
| @ 208 V, 60 Hz | 12 | 25 |
| @ 230 V, 50 Hz | 14 | 28 |



Please refer to all applicable local codes and regulations for the proper installation of this product.

4. Mounting

Orientation

Each REM 1 and REM 1SQ is constructed of aluminum. This ensures each panel is stable and easy to install. Each panel also has convenient built-in handles located on the top and bottom of the backside of the panel along with two alignment conicals on the top and two alignment bolts (feet) on the bottom. This combination enables the user to easily pick up and securely hold each panel while mounting and working. The REM 1 and REM 1SQ can be assembled to provide any number of modular designs. The panels on the top can be securely hung from a truss or other stable surface. Always hang in a safe position with adequate space for ventilation, configuration, and maintenance. Chauvet recommends following the general guidelines below.

- When selecting an installation location, consider ease of access for operation and routine maintenance.
- Make sure to hang away from any flammable material, as indicated in the [Safety Notes](#) section.
- Never mount in places where rain, extreme temperature changes, or restricted ventilation may affect it.
- Make sure that the structure and attachment points can support the weight before hanging the panels.
- Make sure that all load-bearing hardware used can support the weight.
- See the [Technical Specifications](#) for the weight requirement of each REM 1 and REM 1SQ.



REM panels are ONLY to be mounted in a vertical orientation as shown in this manual. Mounting in other ways may result in serious injury. Side latches are for curving purposes and are not designed to be load bearing.

Mounting Points

- | |
|--|
| <ol style="list-style-type: none"> 1. Threaded Mounting Holes Size M10 (x4) 2. Receiver 3. Curve receiver 4. Latch 5. Feet (Alignment Bolts) (x2) 6. Handles |
|--|

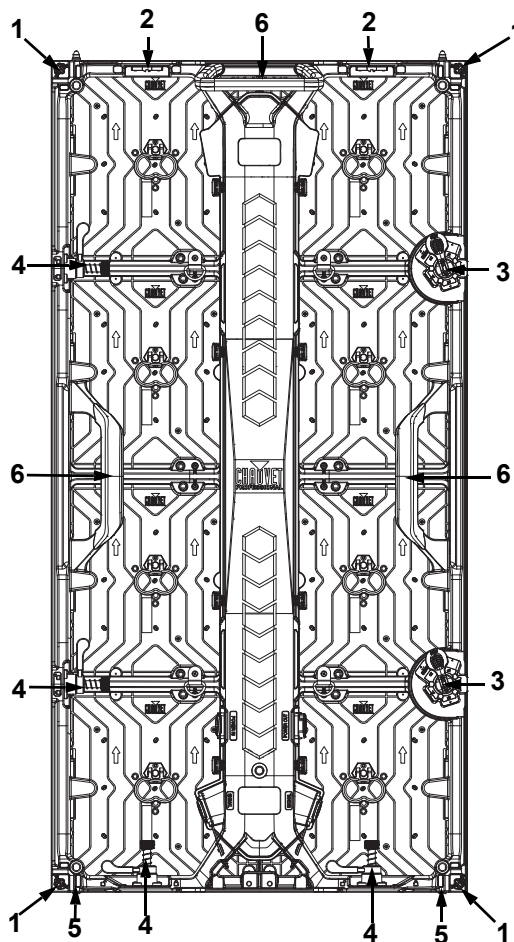

Chauvet offers multiple mounting options for REM-series products, including overhead hanging, rear mounting, and the ground stack kit. REM-series products are not designed to sit directly on the floor or directly on flat surfaces. Doing so may cause damage to the LEDs, which is not covered under warranty. Please contact Chauvet Sales or Technical Service for more details on the offered mounting solutions.

Mounting

REM-RB 50CMIP CURVE Dual Function Rig Bar Dimensions

Sold Separately

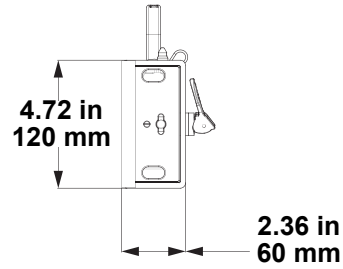
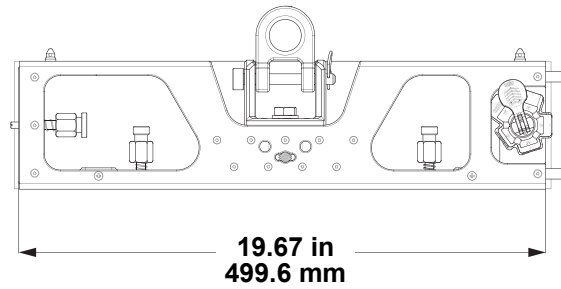

REM-RB 100CMIP Dual Function Rig Bar Dimensions

Sold Separately

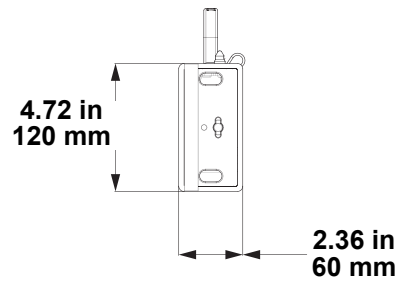
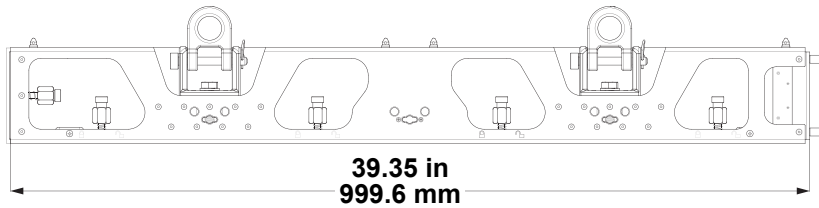

Mounting/hanging with Dual Function Rig Bar

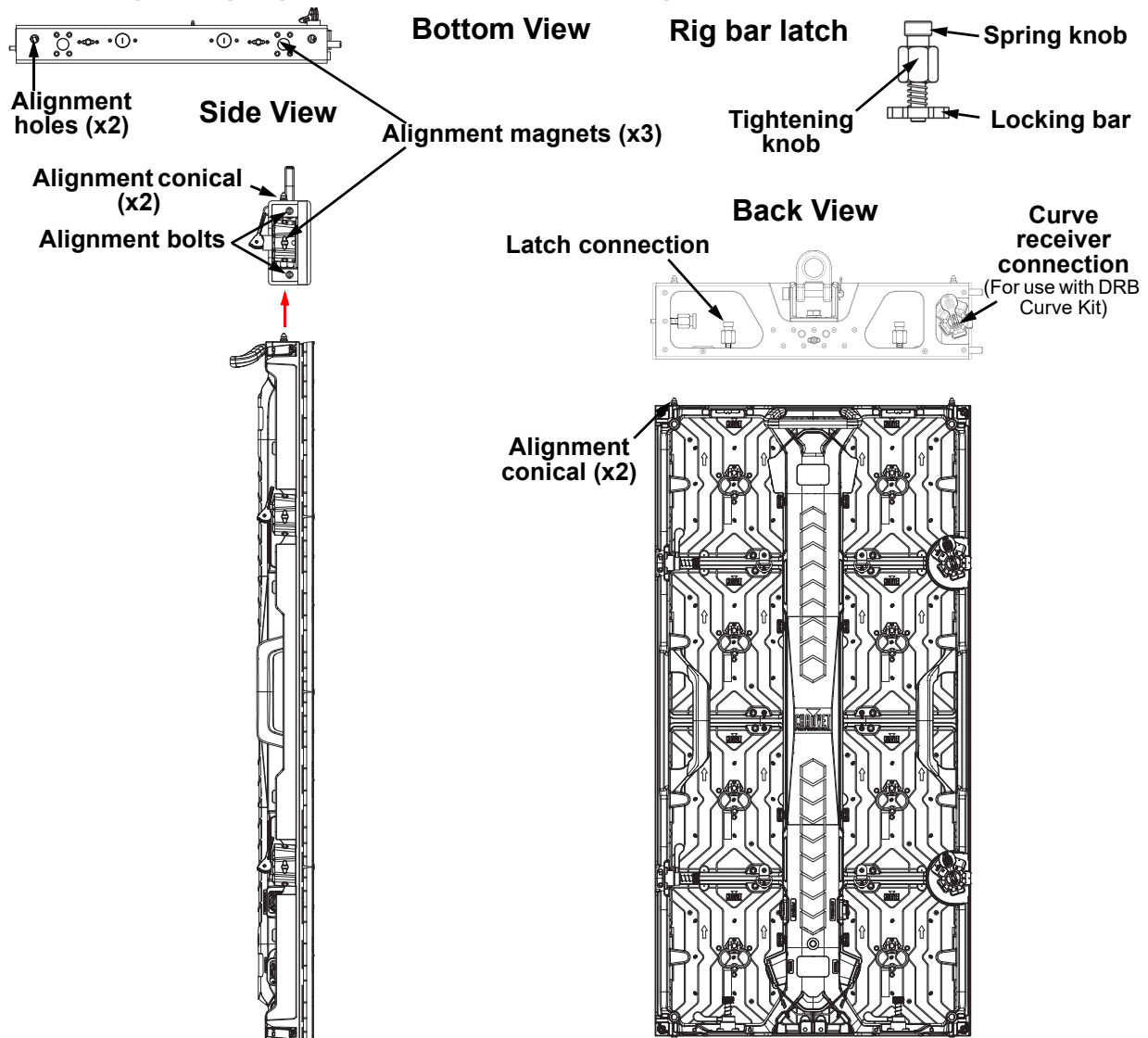

1. Loosen the spring knobs on the latch connections of each rig bar to be used.
2. Insert alignment conicals into the alignment holes and allow magnets to connect.
3. Insert the rig bar latch locking bars into the receiver connections on the REM 1 and REM 1SQ.
4. Twist the spring knob on the rig bar latch until it locks into place.



When mounting a video panel assembly together, mount the entire top row of panels using only the spring knobs before moving on to step 5.

5. Twist the tightening knobs clockwise until the REM 1 and REM 1SQ products are secure to the rig bars and aligned correctly to each other.
6. Install the side latches of the panels to each other ([Horizontal Panel Connection](#)) only after ensuring the alignment is correct.
7. To detach the Rig Bar from the REM 1 and REM 1SQ, reverse the previous steps. Tilt the panels away from each other to safely release the magnetic attachments.



The alignment magnets on the REM 1 and REM 1SQ and dual function rig bar are designed to temporarily hold the weight of the panel to allow the user to properly align and tighten the panel into place.



Warning! The magnetic attachments are not load-bearing, and are intended for alignment assistance only. Do not release panel until the hanging hardware has been fully secured.

Mounting

Curving the Panels

The curve receiver of the REM 1 and REM 1SQ and REM -RB50 CM IP Curve allows a convex or concave angle between rig bars and video panels without additional accessories.

To set the angle to -5° (convex), -2.5° (convex), 0° (straight), $+5^\circ$ (concave), or $+10^\circ$ (concave):

1. Pull the locking lever out, unlocking the curve receiver.
2. Rotate the curve receiver so the receiver at the desired angle is in the connection position.
3. Push the locking lever in, locking the curve receiver in place.

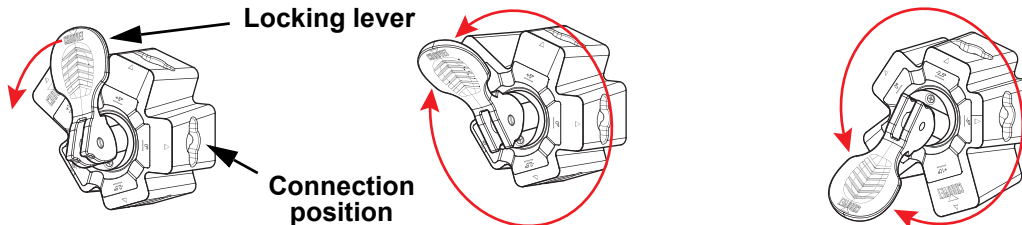

Adjusting the Height

When connected video panels aren't aligning 100% correctly, adjusting the height of the rig bar hoist ring even the smallest amount can correct the issue.

Turn the height adjustment bolt with an adjustable wrench to adjust the height of the hoist ring.

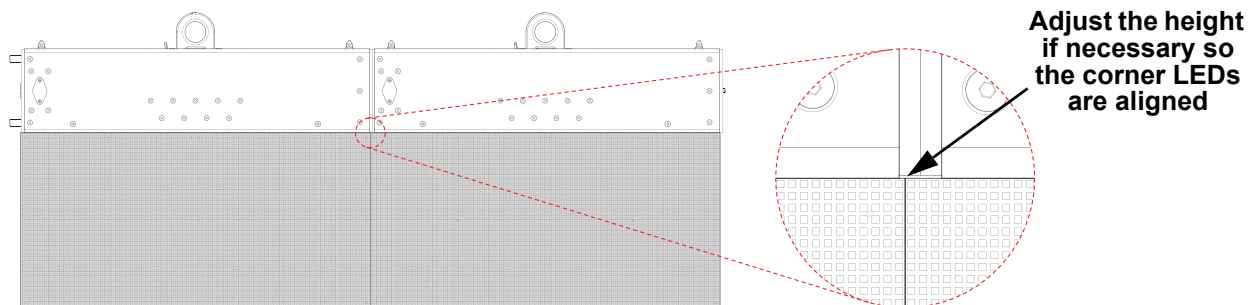
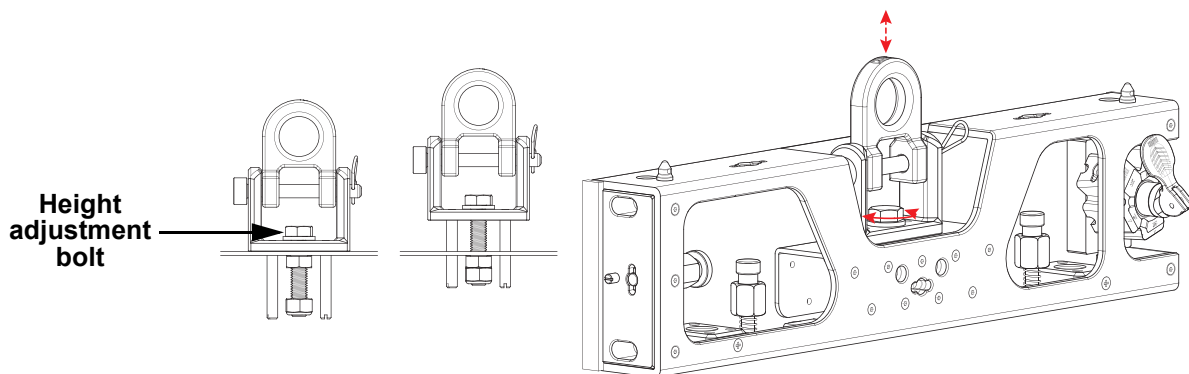

Truss Installation

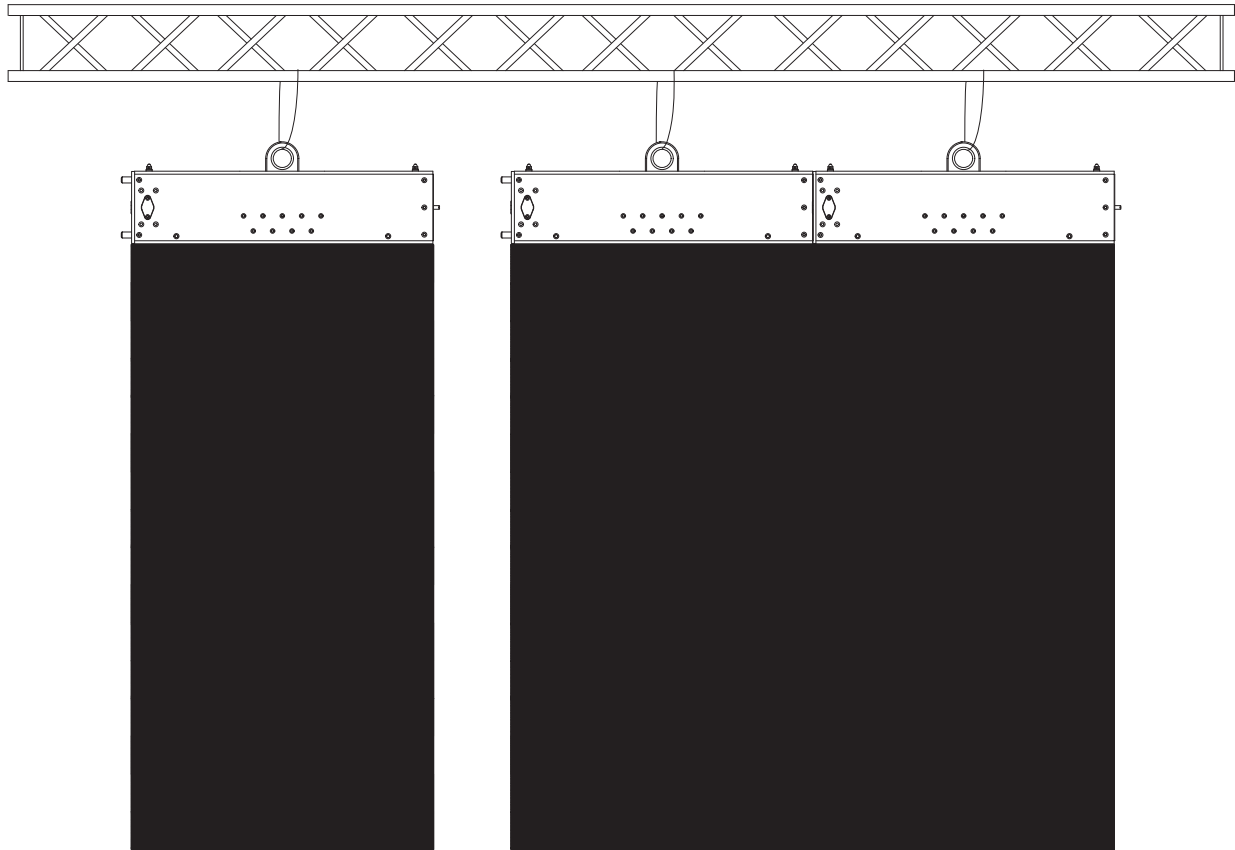
Attach to Truss Using Dual Function Rig Bar

The M10 mounting points are not intended for hanging or suspending from a truss or other overhead structure.

In order to suspend/hang the panels from a truss or other overhead structure, use the Dual series rig bars (REM-RB50CMIPCURVE or REM-RB100CMIP, sold separately).



All applicable local codes and regulations apply to proper installation of this product.



WARNING: The alignment magnets on the dual function rig bars are not designed for load bearing! All rig bars in a panel assembly must be mounted individually to the mounting point! Adjacent rig bars will NOT support the attached weight!



WARNING: This product should only be used by competent and qualified persons.

Mounting/Stacking with Dual Function Rig Bar

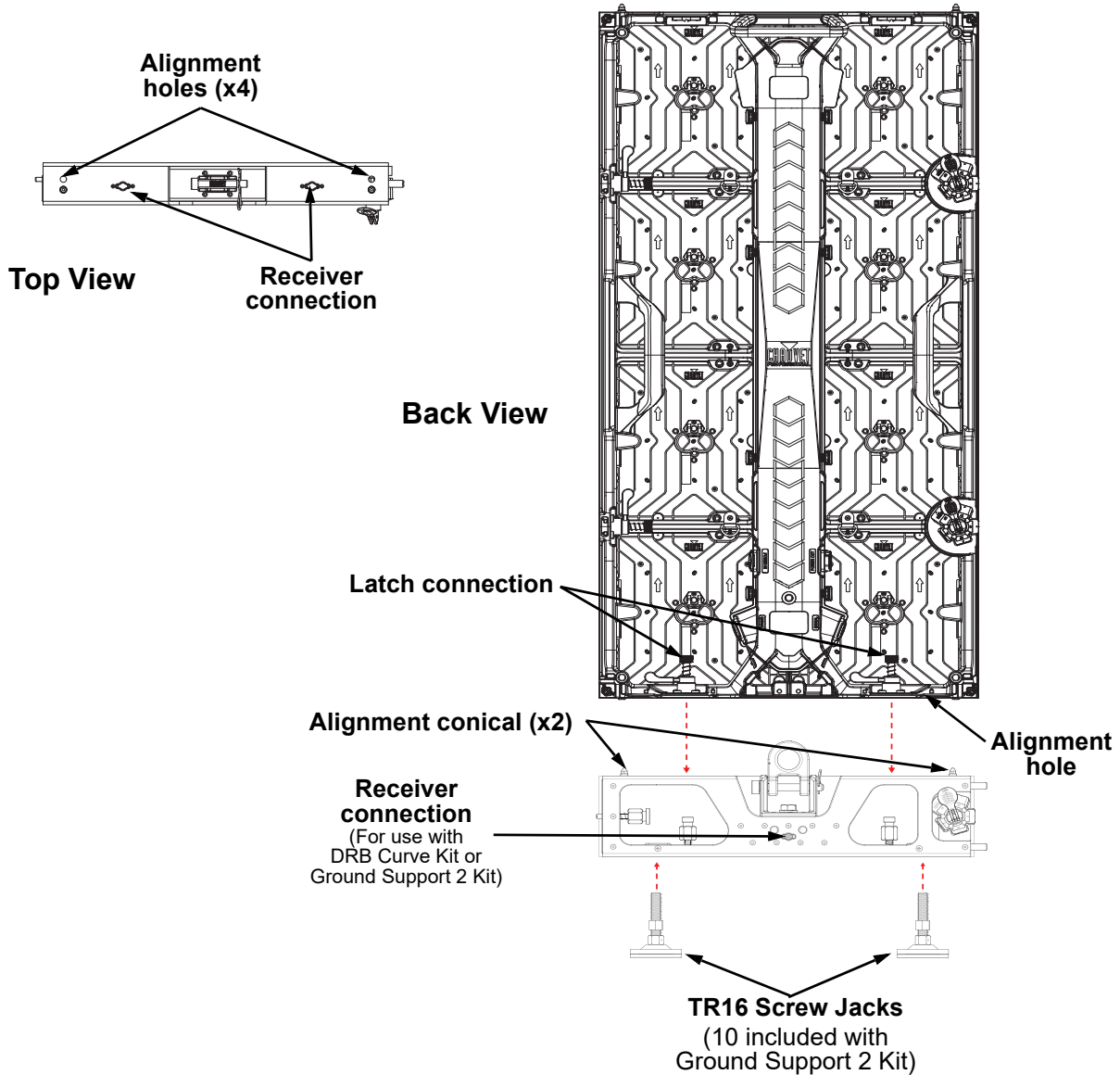

1. Insert alignment conicals into the alignment holes and allow magnets to connect.
2. Close the latches of the latch connections on the REM panel.
3. To detach the rig bar from the panel, reverse the previous steps.



Warning! The magnetic attachments are not load-bearing, and are intended for alignment assistance only. Do not release panel until the hanging hardware has been fully secured.

Removing the Feet

To remove the feet (alignment bolts) from the REM 1 and REM 1SQ, twist them counter-clockwise with a 16 mm wrench until they come loose.



Back View



Side View

9.38 mm



Removing the feet may result in damage not covered by the warranty.

Flat Wall Installation

Refer to the following diagrams for flat wall installation.

Mounting Points on a Flat Wall

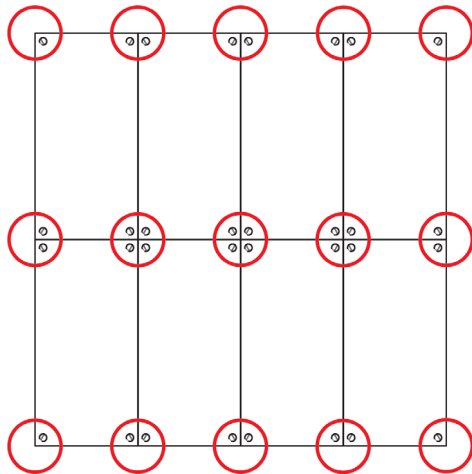

At least 1 mounting point for every junction (circled) must be secured, including outside edges and corners

Rear
Threaded Mounting Holes
Size M10 (x4)

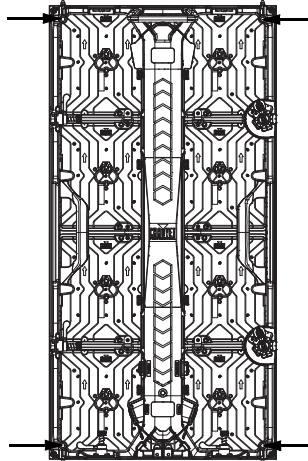

M10 bolts must be used for rear mounting applications

Front
Mounting Holes
Size M8 (x4)

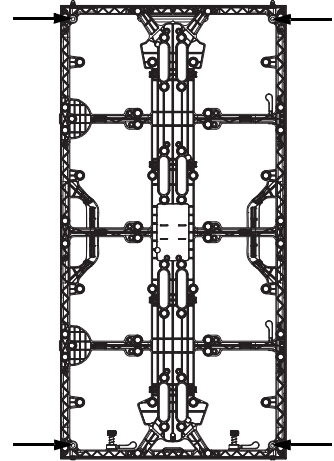

M8 bolts are compatible for front mounting applications



The 4 rear and front mounting holes are intended for flush mount installation to a flat surface against the video panels. 1 mounting point for every junction, including outside edges and corners, must be used in order to maintain structural integrity. The mounting points are not intended for hanging or suspending from a truss or other overhead structure.

The 2 rear mounting holes in the middle of the product are intended for use with the Ground Support 2 Kit from Chauvet.

Mounting with Steel Struts

Chauvet recommends using a VERTICAL steel strut for each column of panels, plus 1, as in the following diagrams:

4 columns + 1
= 5 steel struts

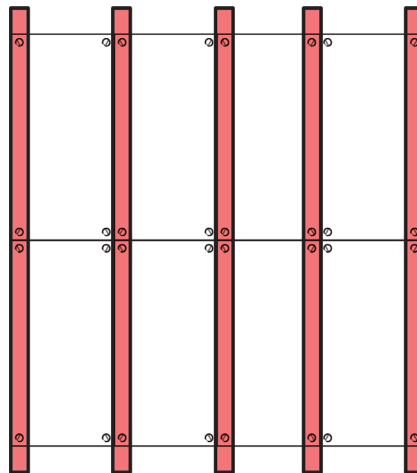

Spacers greater than 6.5 mm thick must be used at each mounting point, between the panels and the struts.



The illustrations above are examples only. Please refer to all applicable local codes and regulations for the proper installation of the product.

Mounting

Flat Wall Installation

When mounting to a flat wall, use 6.5 mm thick spacers at each mounting point, between the panels and the struts, as in the diagram below.

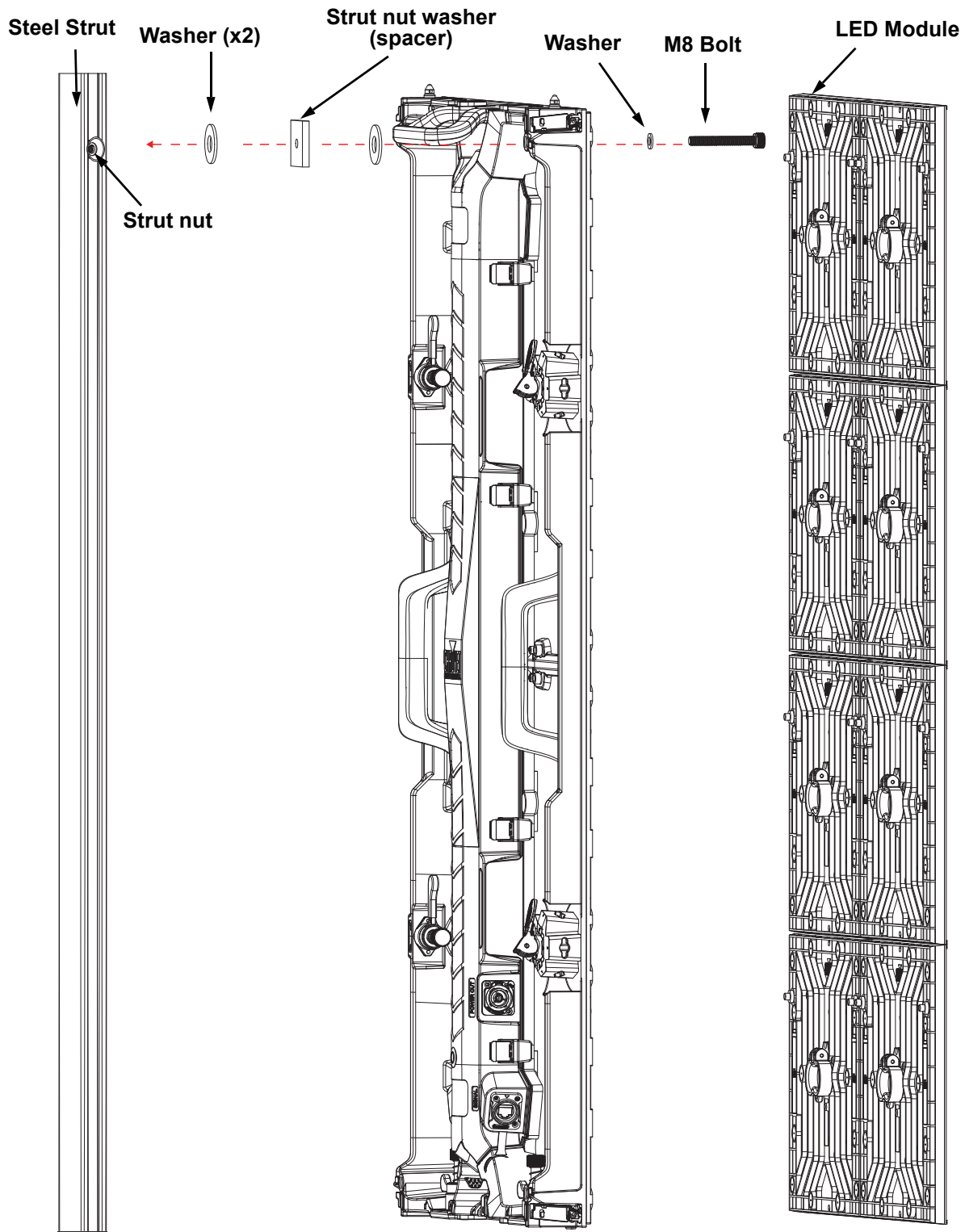

Safety Cable Installation

Safety cables may be attached to the REM 1 and REM 1SQ. To attach safety cables to the REM 1 and REM 1SQ, follow the instructions below:

1. Attach the clip at one end of the safety cable to the handle of the module.

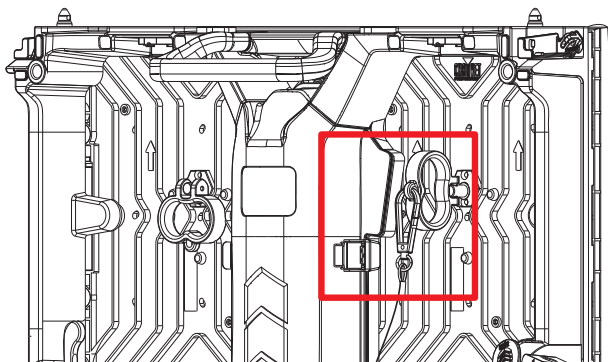

2. Attach the clip at the other end of the safety cable to the frame.

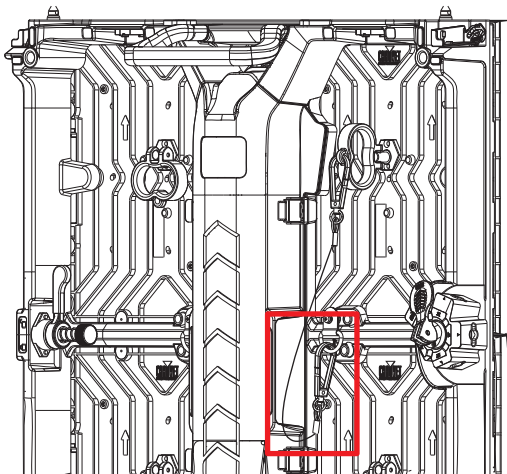

3. Repeat steps 1-2 to secure other modules using the safety cable.

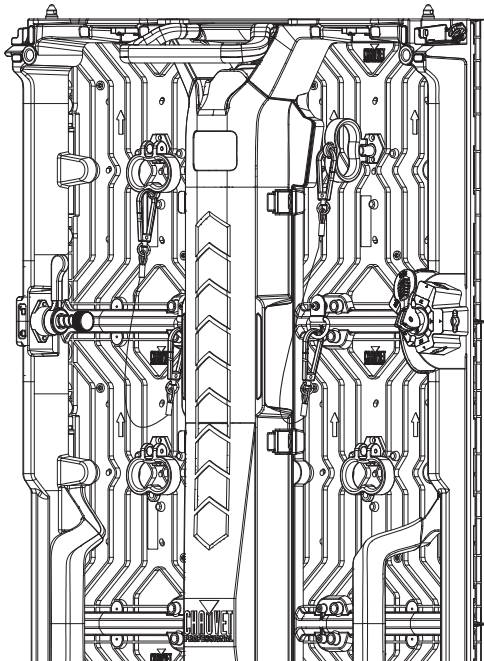

5. Joining Each REM 1 and REM 1SQ

Vertically Joining the Panels

Each REM 1 and REM 1SQ can be easily joined vertically to a truss using an optional rig bar and the 2 receiver connections located at the top of each panel. Use the latch connections at the bottom of each panel to connect additional panels. These connectors stay recessed when not being used.

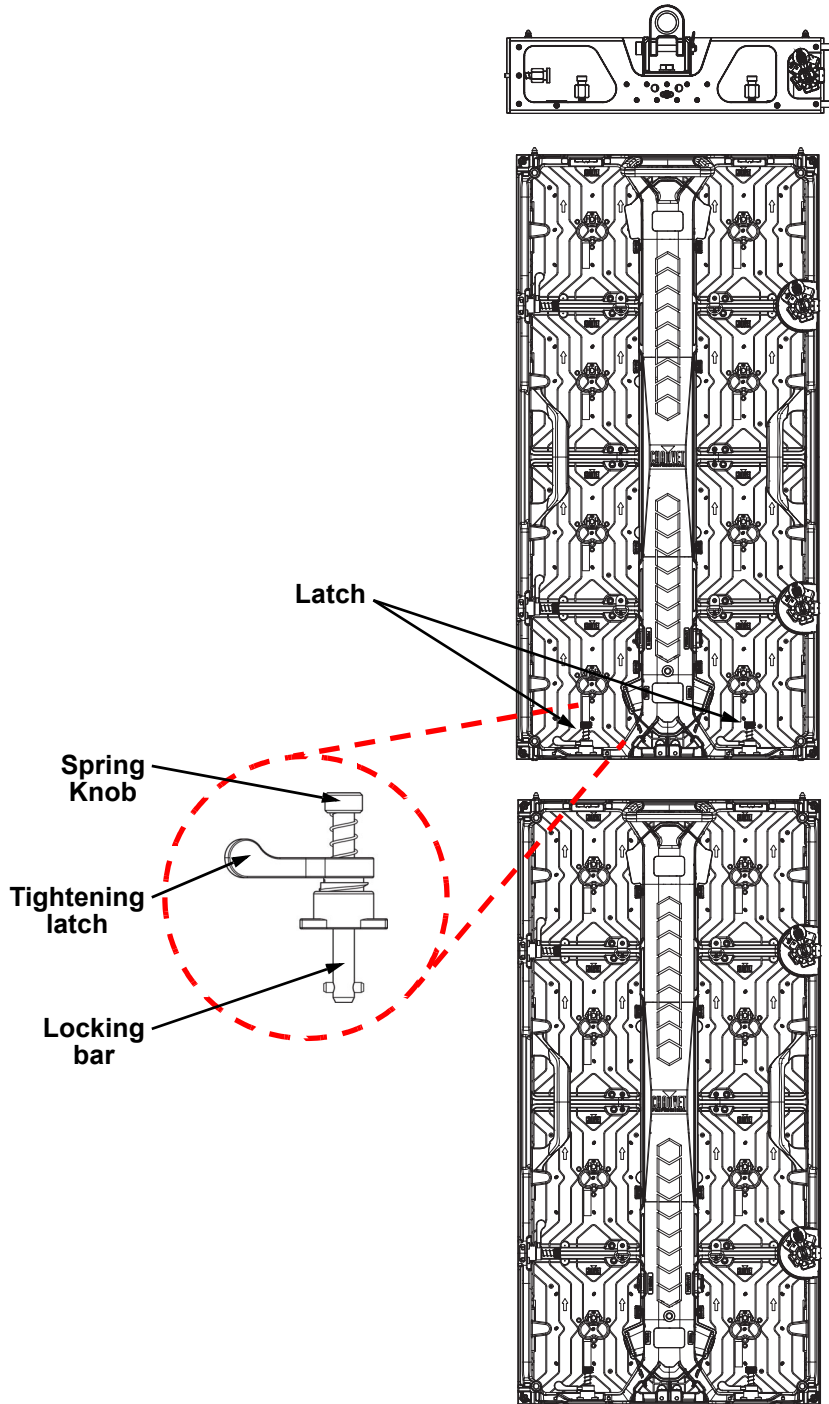

Vertical Panel Connection

Use the following instructions to join panels vertically:

1. Line up the alignment conicals at the top of each panel, and the alignment magnets at the top and bottom of each panel.
2. Push latch connections into receiver connections.
3. Turn the spring knobs clockwise until secure.
4. Turn the tightening latches counter-clockwise until secure.



Due to tolerances in the materials, as well as wear and tear of the latches, some tightening latches may not line up when tightened. This is normal.

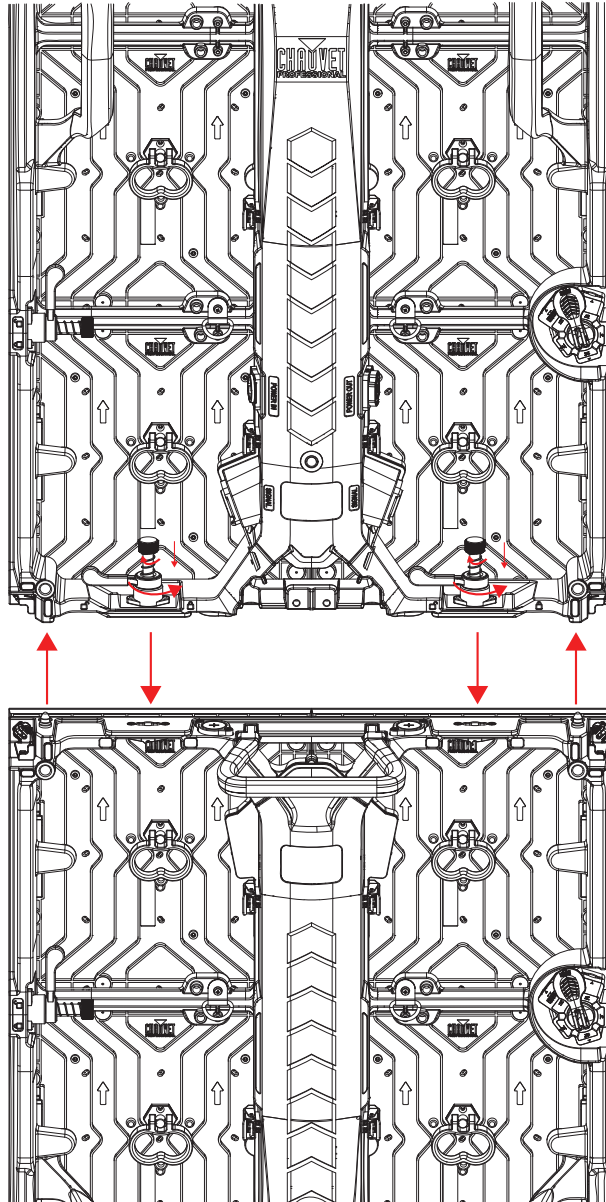

Warning! The magnetic attachments are not load-bearing, and are intended for alignment assistance only. Do not release panel until the hanging hardware has been fully secured.

Joining Each REM 1 and REM 1SQ

Horizontally Joining the Panels

Each REM 1 and REM 1SQ can be joined horizontally using the latch connections on the inside, upper and lower left sides of each panel.

Horizontal Panel Connection

Use the following instructions to join panels horizontally:

1. Align each of the panels' latch connections with the corresponding curve receiver connections on the panels being added.
2. Push latch connections into curve receiver connections.
3. Turn the spring knobs clockwise until secure.
4. Turn the tightening latches counter-clockwise until secure.



Due to tolerances in the materials, as well as wear and tear of the latches, some tightening latches may not line up when tightened. This is normal.

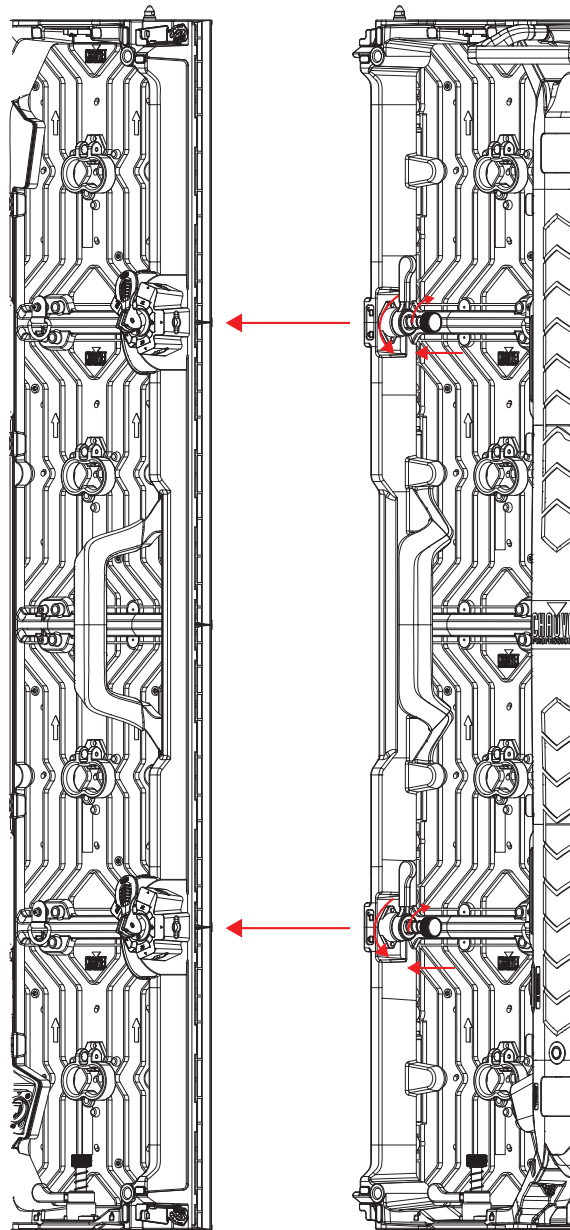

6. Connecting & Cabling Each REM 1 and REM 1SQ

Testing Signal and Power Connections

Each REM 1 and REM 1SQ have 2 power sockets and 2 signal ports. The following table outlines each of the indicator functions.

| Indicator | Color | Status | Description |
|-------------------|-------|---------------------------|--|
| Running indicator | Green | Flashing once per 1s | Receiving card function and Ethernet cable is normal. Video source input available. |
| | | Flashing every 3s | Ethernet cable connection is abnormal. |
| | | Flashing 3 times per 0.5s | Ethernet cable is normal, but no video source input is available. |
| | | Flashing once per 0.2s | Receiving card failed to load program in the application area. Receiving card is using the backup program. |
| | | Flashing 8 times per 0.5s | A redundancy switchover occurred on Ethernet port and the loop backup has taken effect. |
| Power indicator | Red | Always on | Power input is normal. |

Rear Panel Views

Underside of Service Access Views

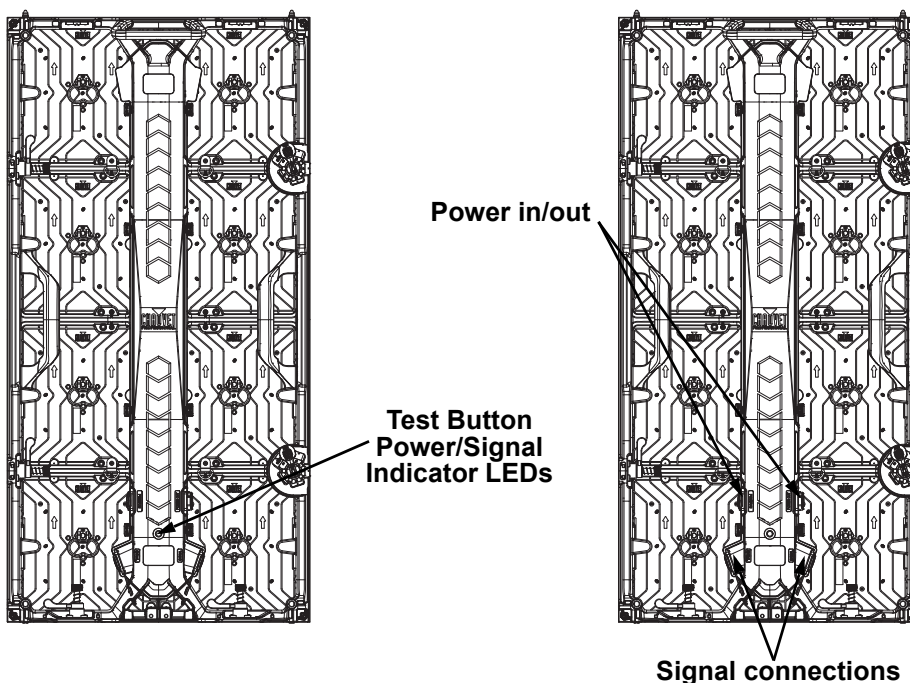

Using the REM 1 and REM 1SQ Test Button

Each REM 1 and REM 1SQ has a test button, used to ensure all LEDs are functional. Use the test button on each panel to perform a self-test. If self-testing, the user must perform the test individually for each REM 1 and REM 1SQ. It is not necessary to connect to a signal or use software.



When using the Test button, make sure the REM 1 and REM 1SQ is NOT connected to the Novastar MX40 Pro.

To use the Test button, the user must connect the power, but do not connect the signal cables. Press the Test button to toggle through various LED light display configurations.

Connecting & Cabling Each REM 1 and REM 1SQ

Connecting Power and Signal Cables

The following sections provide information and diagrams on connecting signal and power between panels. Refer to the [Introduction](#) or [Operation](#) sections in this User Manual for available cables and item numbers.

Connecting the Signal Between Joined Panels

Signal cable panel connections can use several different configurations. The basic configuration to connect the signal from one panel to the next is as follows:

1. The source signal is connected to the first panel.
2. A signal cable is then connected from the first panel.
3. The connections continue to daisy-chain until all panels are connected.
4. The route of the cables used to make the signal connections can vary.

The following diagram is a recommended suggestion for simple signal connections between panels.

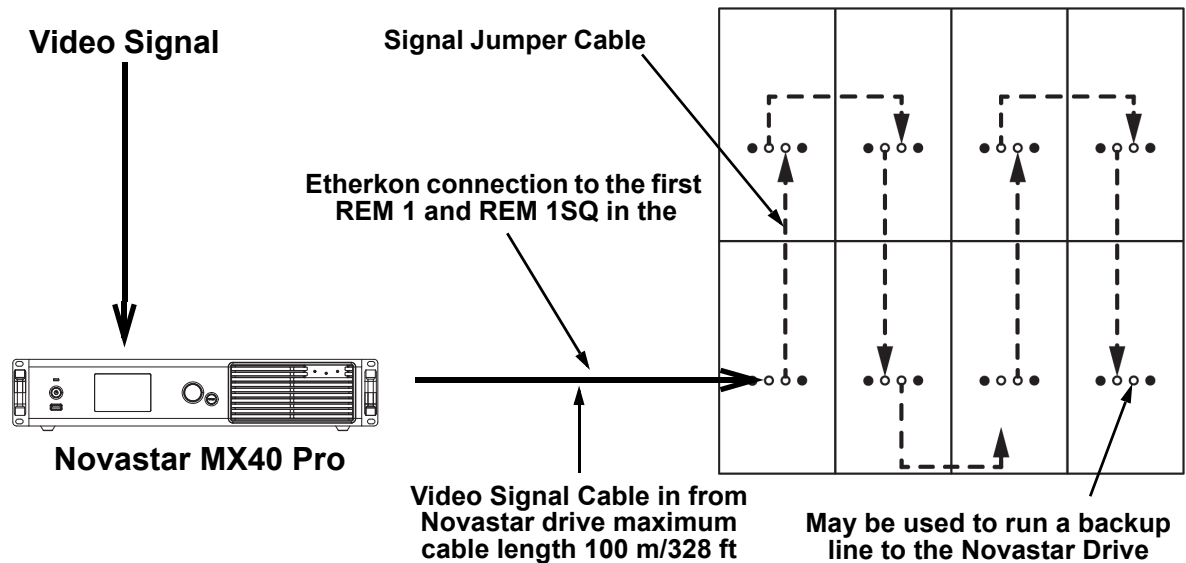

To calculate the number of panels, horizontally and vertically, supported by a single Novastar MX40 Pro sender, use:

- The number of pixels per panel.
- The screen resolution desired for the video wall display.



The Novastar MX40 Pro Sender is required to operate an REM 1 and REM 1SQ video wall system. Diagrams of how the REM 1 and REM 1SQ panels and the Novastar VMP Platform connect follow later in this manual. For detailed information about the Novastar VMP Platform and panel calculation examples, refer to the User Manual for the Novastar MX40 Pro Sender.

Signal Chain Rectangles

When panels are assembled together to output video from a Novastar MX40 Pro, they form horizontal rows and vertical columns in rectangular arrangements.

Each port of one of the Novastar MX40 Pro driver can support multiple REM 1 and REM 1SQ panels. If the amount of panels used exceeds the maximum, more than 1 output port from the Novastar MX40 Pro will be required. Pixels for each port are calculated as whole rectangles. Even if all panels within a rectangle are not connected to a port, the total panels in the rectangle must be within the limits of the port.

Connecting panels to a single port in an arrangement which creates a rectangle larger than the maximum permitted will result in error.

Of the following examples, only those where both of the following are true can work:

- The number of panels connected to each port is equal to or less than 20.
- The panels connected to each port individually form a rectangle which includes 20 panels or fewer.

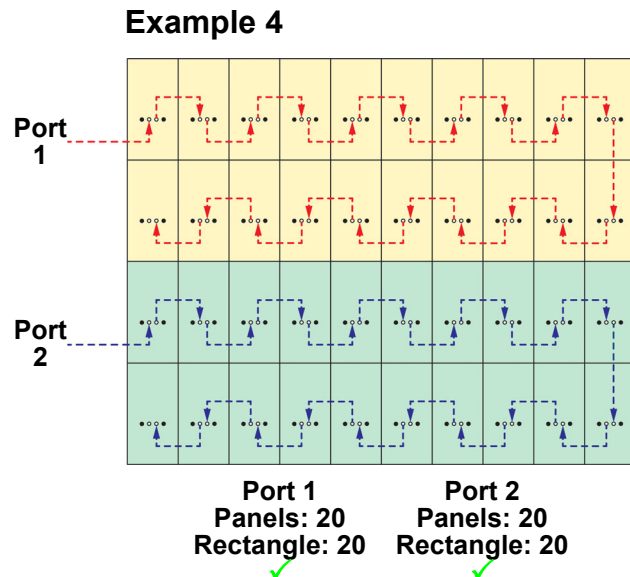
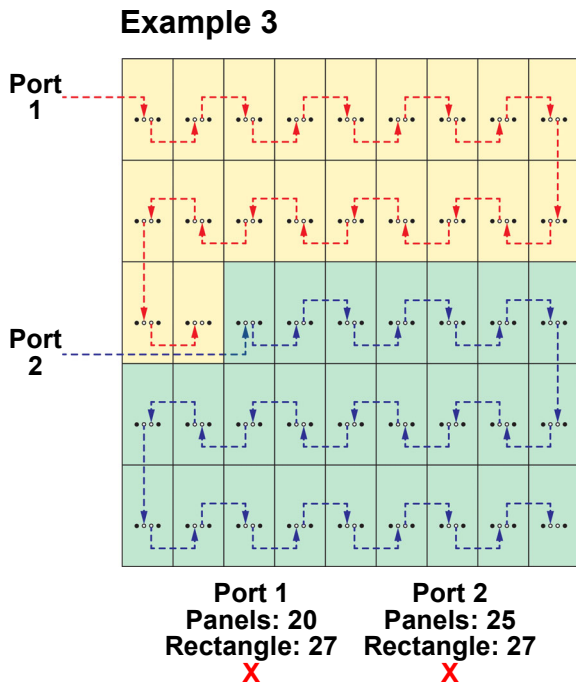
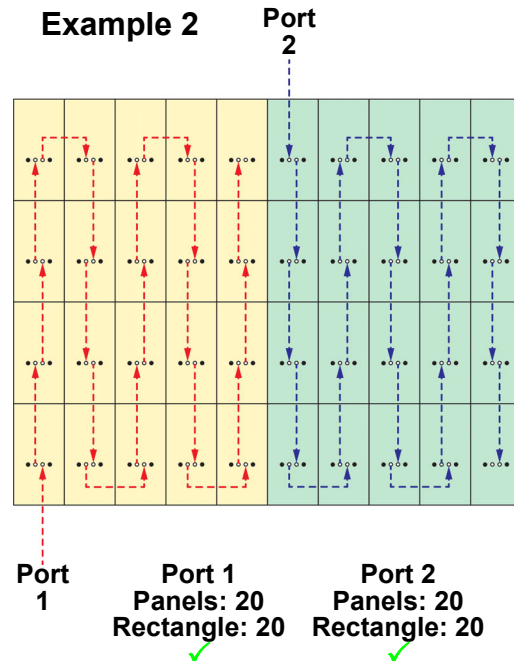
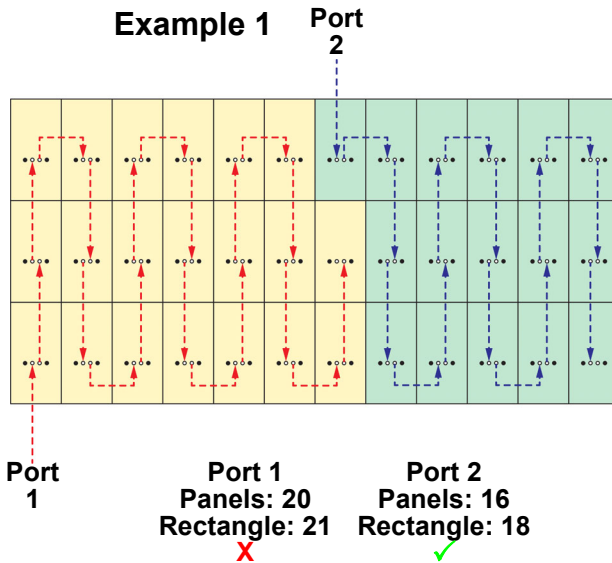

Connecting & Cabling Each REM 1 and REM 1SQ

Connecting the Power Between Joined Panels

Power cable panel connections can also use different configurations. The basic configuration to connect the main power supply from one panel to the next is:

1. The main power is connected to the first panel's Power Input or Output.
2. A power cable is then connected to the first panel's Power Output and connected to the next panel's Power Input.
3. The connections continue until all panels are connected.

Connect power between the panels using the same procedure as the signal only using the Power Input and Power Output connectors. Always adhere to the power-linking specifications for each REM 1 and REM 1SQ model.

Refer to the [Power Linking](#) section for details on the number of panels that can be linked based on voltage from a single power connection.



Power linking more panels than recommended will void the product's warranty and increase the risk of electrocution or fire!

Refer to the following diagrams for an example of power connection from the main and to each connected panel.

This example is using the REM 1 and REM 1SQ power linking 5 panels horizontally @ 120 V.

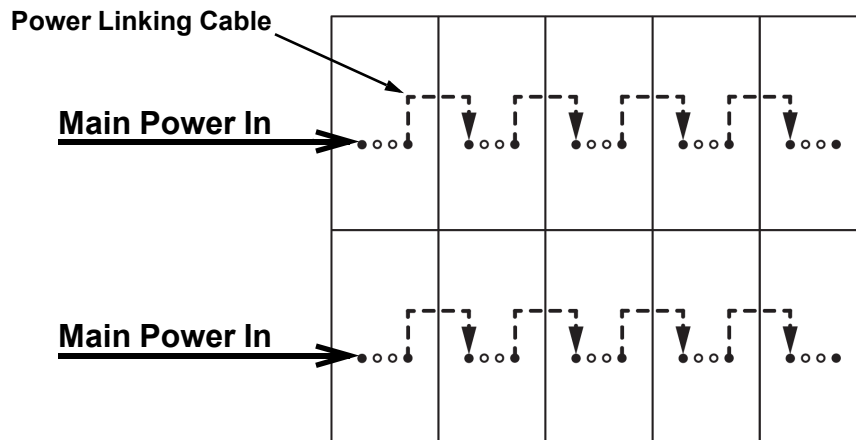

7. LED Module Care and Replacement

REM 1 and REM 1SQ Modules

Each REM 1 and REM 1SQ has 4 or 8 LED modules connected to the panel frame by magnets. Each module has connectors that connect to the main processing unit.

Module Description

To ensure consistent color matching and output, replace damaged or defective modules with the same LED lot # as the others on the panel. When combining panels to create full video wall systems (rentals, permanent installations, etc.) it is highly recommended that the LED lot #'s on each of the panels match. LED lot #'s can be located on the back of each module.

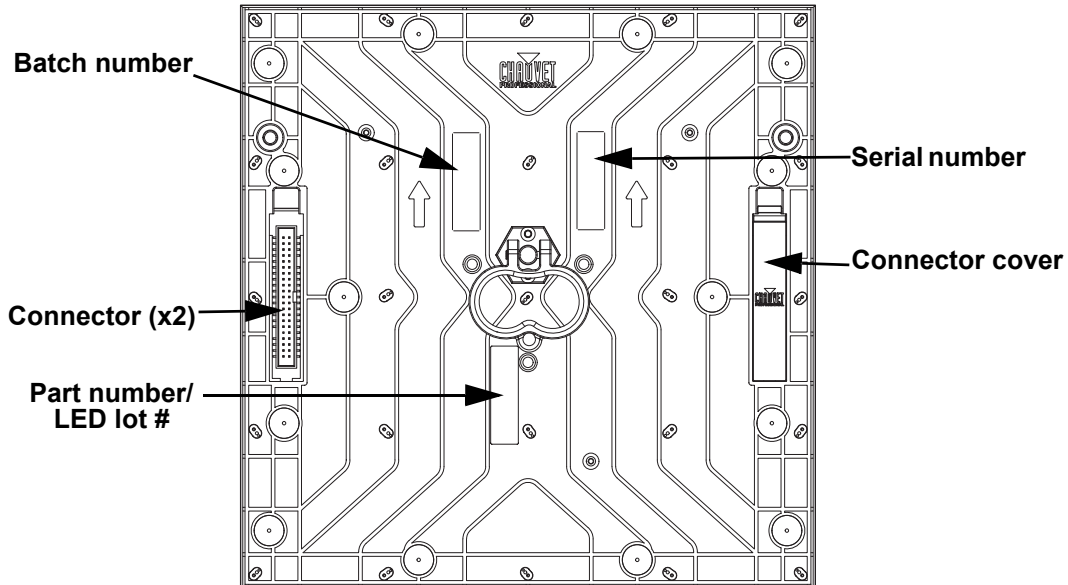

REM 1 and REM 1SQ



The arrows on each module point towards the top of the panel when correctly installed.



When attaching the module to the control module, remove the connector cover and place it over the connector not in use.

Calibration Recall

Each LED module for the REM 1 and REM 1SQ has individual calibration data for each LED permanently saved to the flash memory of the module. The receiver card inside the control box (or Control module) of the REM 1 and REM 1SQ can use that data to ensure a uniformity of brightness across the entire panel. To upload the calibration data from a new LED module to the Control Module of the panel, follow the instructions below.

Without a Computer

1. Unplug any signal cables and power the product off.
2. Hold the Test Button down and power the product on.
3. Continue to hold the Test Button down for 10 seconds.
4. Release the Test Button. The signal indicator will flash rapidly while it downloads the calibration data from the module.
5. When the signal indicator stops flashing rapidly, the new module will have been matched automatically to the rest of the panel.

With a Computer

See the COEX VMP user manual for instructions on how to perform a calibration recall with a computer.

8. REM 1 and REM 1SQ Serviceability

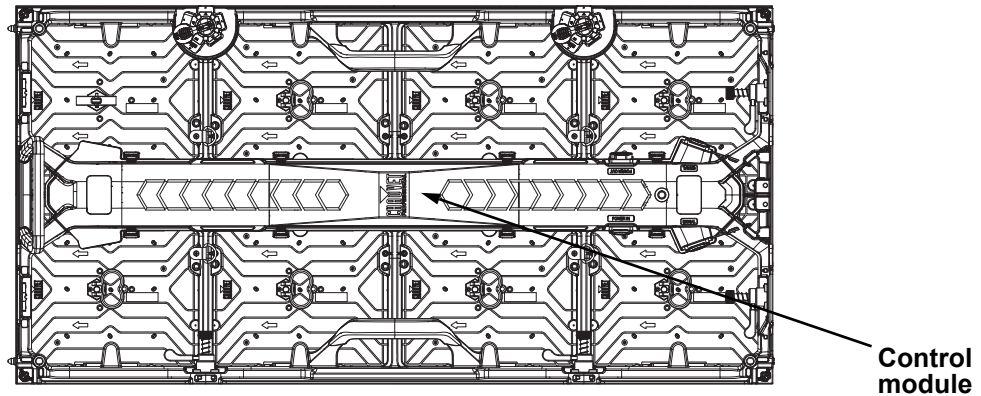

The REM 1 and REM 1SQ control module can be accessed and serviced from either the front of the panel or the rear of the panel at any time, so panels can be serviced when access to either the front or the rear is restricted or impossible. To access the REM 1 and REM 1SQ control module from the rear of the panel, unhook the hinged latches indicated in the diagram below.

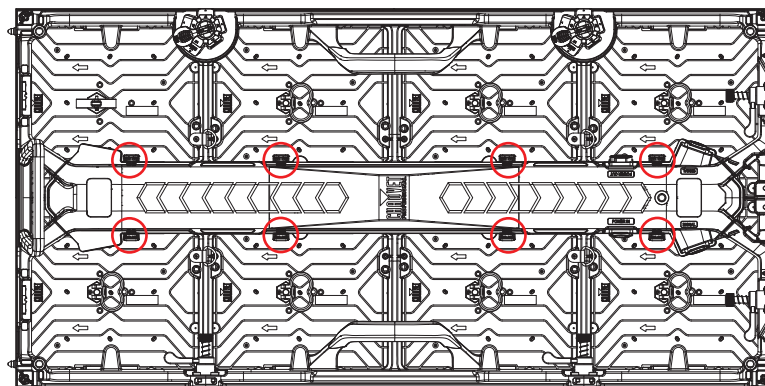

Use caution when unhooking these latches, as the cover of the control module will be detached from the panel frame. All components in the control module are attached to the cover.

9. Typical REM 1 and REM 1SQ Hanging installation

Because a video wall system can include different components to provide a simple to complex modular wall design, use the following steps as a general guide to get started.

Step 1

Open and examine the REM 1 and REM 1SQ road case to make sure all products and accessories are present and that each one is in good condition.

Step 2

Apply power and run the self-test for each REM 1 and REM 1SQ to ensure all LEDs and inside connections in each panel are working (optional).

Step 3

Create a stable mounting surface (e.g., truss or other stable surface) for REM 1 and REM 1SQ mounting.

Step 4

Mount the first top row of the REM 1 and REM 1SQ products. Refer to the [Mounting](#) section in this User Manual.

Step 5

Adjust the alignment of the first row using the curve receivers / latches.

Step 6

Connect the signal source to the Novastar MX40 Pro.

Step 7

Connect the Novastar Drive to the Signal port of the first panel in the connection chain.

Step 8

Based on the desired video wall configuration (design), join each panel, horizontally and/or vertically, using the instructions in the section [Joining Each REM 1 and REM 1SQ](#).

Refer to the instructions and information in the [Connecting & Cabling Each REM 1 and REM 1SQ](#) section of this User Manual.

10. Operation

Additional Hardware and Software

In addition to the panels, the user will need other hardware and software to design, build, and operate the REM 1 and REM 1SQ video wall system. The following table summarizes these additional items—some are required and others are optional.

| Item | Description |
|---|---|
| Novastar MX40 Pro | Interface between the signal source, Nova VMP, and the REM 1 and REM 1SQ being used |
| Nova VMP | Software applications used to design and run the REM 1 and REM 1SQ products comprising the video wall. A PC is needed |
| RB 50CM IP Curve or RB 100CM IP Series Dual Function Rig Bar (optional) | Provides hardware needed to mount REM 1 and REM 1SQ |
| Neutrik® PowerKon Extension (optional) | IP65 Rated Seetronic® Powerkon Extension, 5 ft, 10 ft, and 25 ft |
| Ground Support 2 Kit | Ground support/ stacking system |
| MT07 Universal Module Removal Tool | LED module removal/installation tool |

About Nova VMP

Nova VMP is a powerful and easy-to-learn software application used to design and run the REM 1 and REM 1SQ video wall system. The following is some introductory information about these applications.

Refer to the Novastar MX40 Pro User Manual for detailed information and instructions on setting up and using Nova VMP with the Chauvet REM 1 and REM 1SQ video wall system.

Description

Nova VMP enables the creation and control of a video wall by addressing the panels included in the video wall including pixel pitch and layout.

Once having physically created the modular video wall design by joining the panels, connecting power, signals, and the Novastar MX40 Pro, recreate that design within Nova VMP.

Detailed information and instructions are in the User Manuals for the Novastar MX40 Pro.

Receiver Card Configuration Files

The A10s Pro receiver card configuration files, commonly referred to as NCP files, contain all of the data used to route video signal data from the receiver card to the LED drivers inside the REM 1 and REM 1SQ panels. This data includes:

- LED module layout and quantity
- LED driver model
- Scan mode (number of LEDs in a series)
- Refresh rate
- Grayscale
- Maximum brightness
- Total panel orientation (when compatible)
- Gamma table (dimming curve)
- The signal indicator LED on/off function
- Panel power consumption
- Panel dimensions
- LED quantity
- LED module flash configuration

The NCP file does not contain brightness/chroma calibration data or mapping data (panel layout). Each of these are stored as separate files. To load a new NCP file onto an REM 1 and REM 1SQ panel, follow the steps under [Updating Controller Firmware](#) or [Updating Cabinet Firmware](#).



Ensure the NCP file version matches the firmware version on the panel.

Operating Nova VMP

Selecting a Processor

After launching the software, Nova VMP will detect all connected processors and auto-populate the device list. To select a processor.

1. Launch Nova VMP software and locate the **Device list** menu.

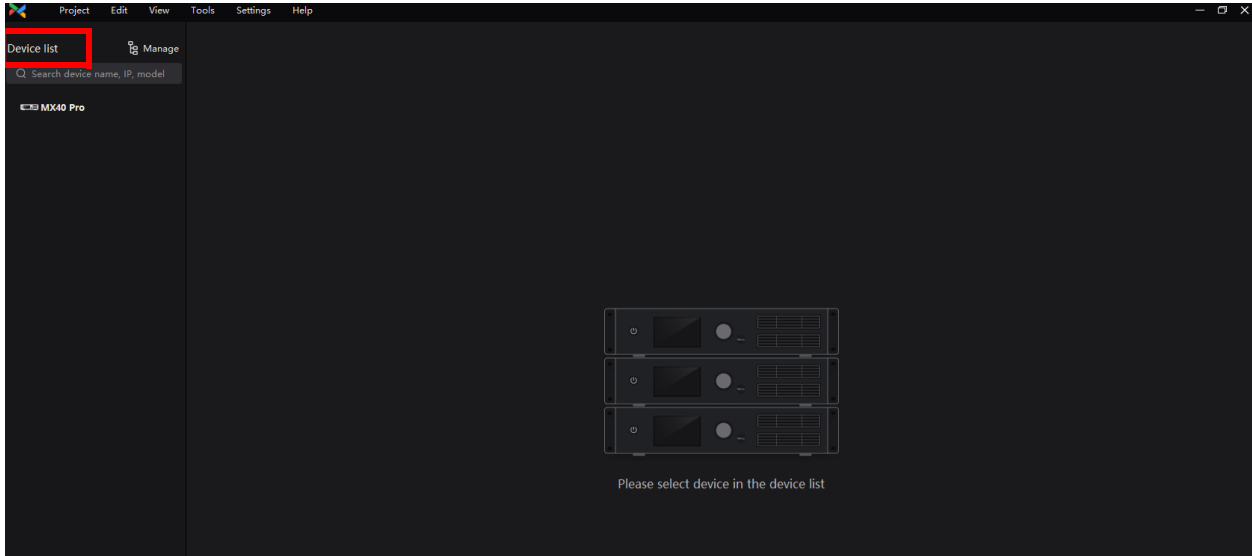

2. Under the **Device list** menu, select the desired processor (i.e. Novastar MX40 Pro).

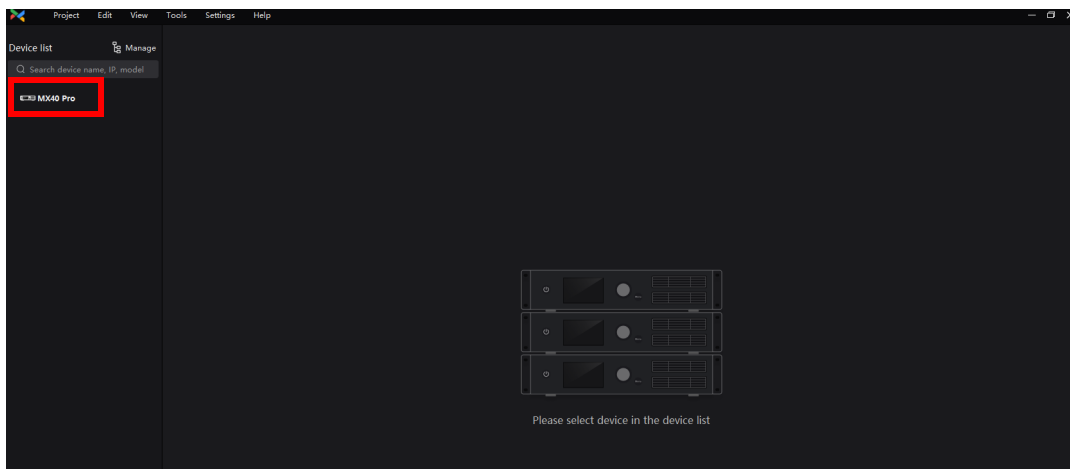

3. Once the desired device is selected, the canvas will populate.

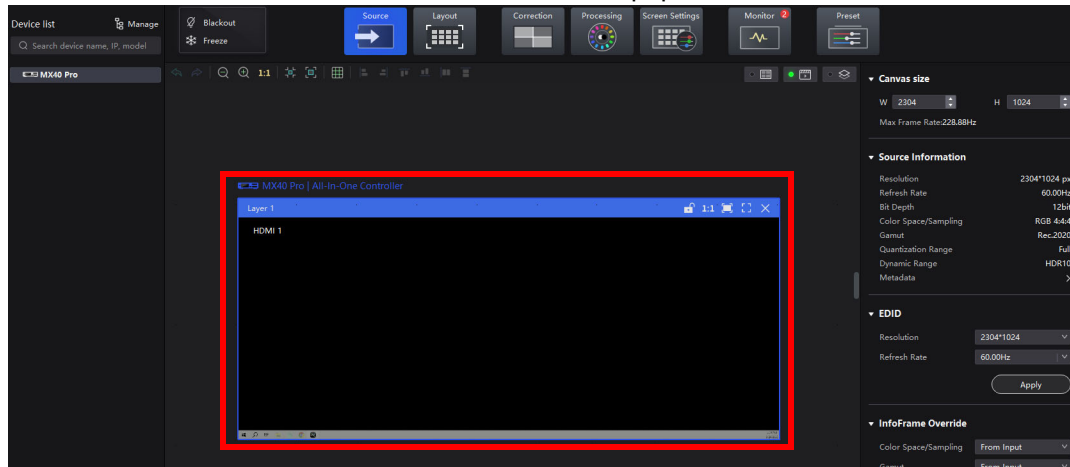

Operation

Selecting a Signal Source

To select a source:

1. Ensure that the **Source** tab is selected. Locate the source list at the bottom of the screen.

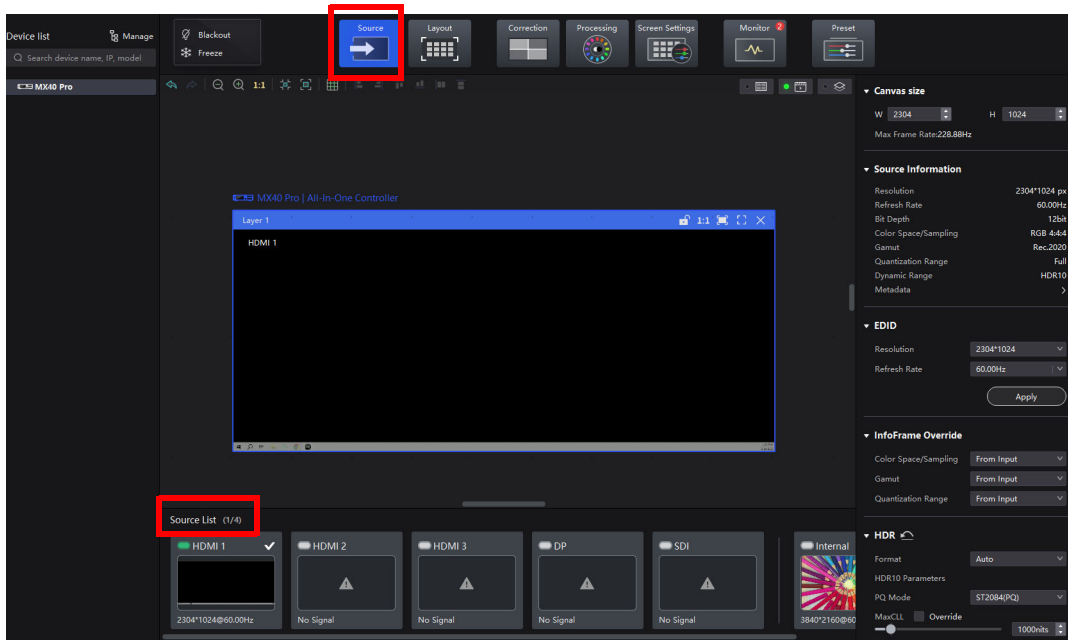

2. Select the desired signal.

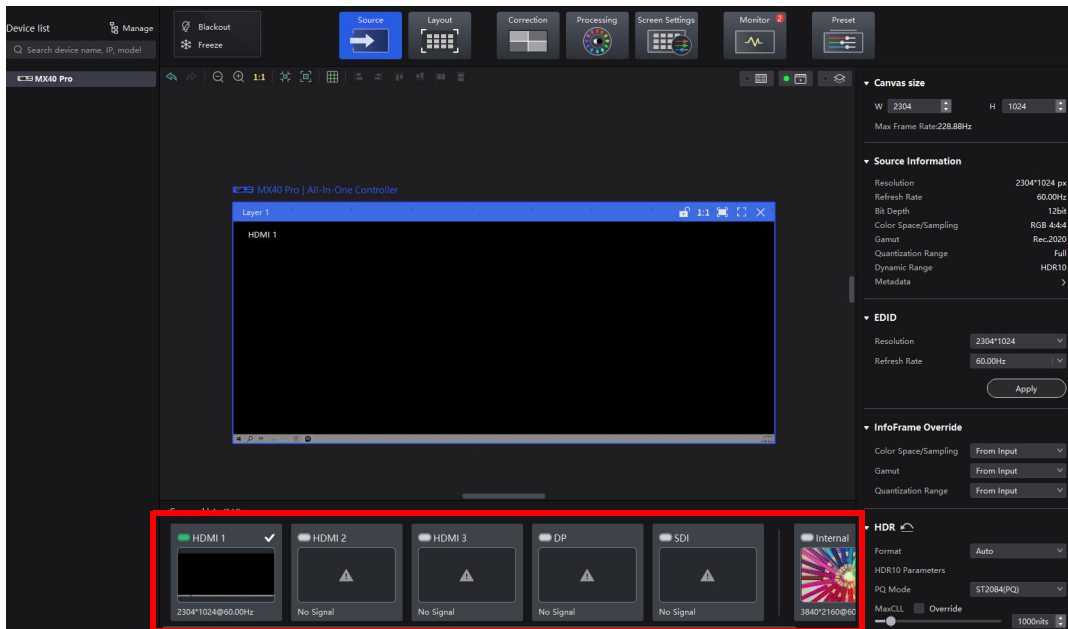

Customizing the Canvas

The canvas is located at the center of the screen. Users can toggle between three different options to customize the canvas. To customize the canvas:

1. Locate the three custom mapping buttons above the canvas.

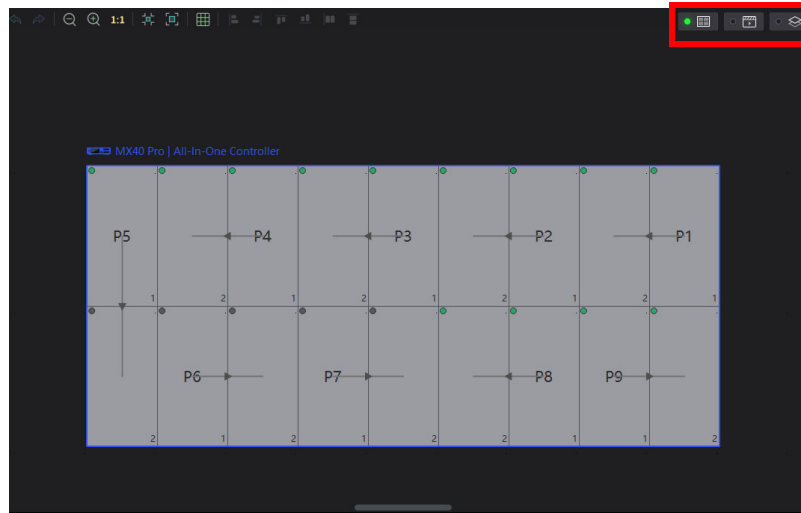

2. Each button will customize the canvas differently. Select the **Cabinet only** button and all panels will be visible on the canvas.

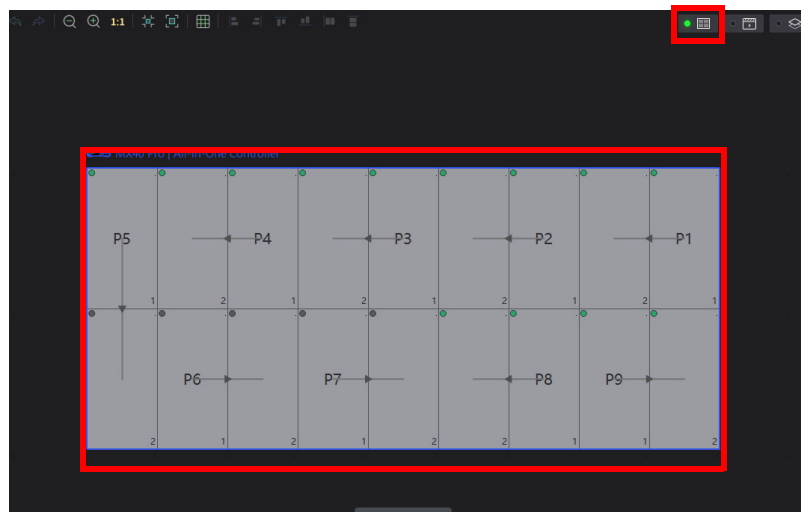

3. Select the **Source Only** button and the source will be visible on the canvas.

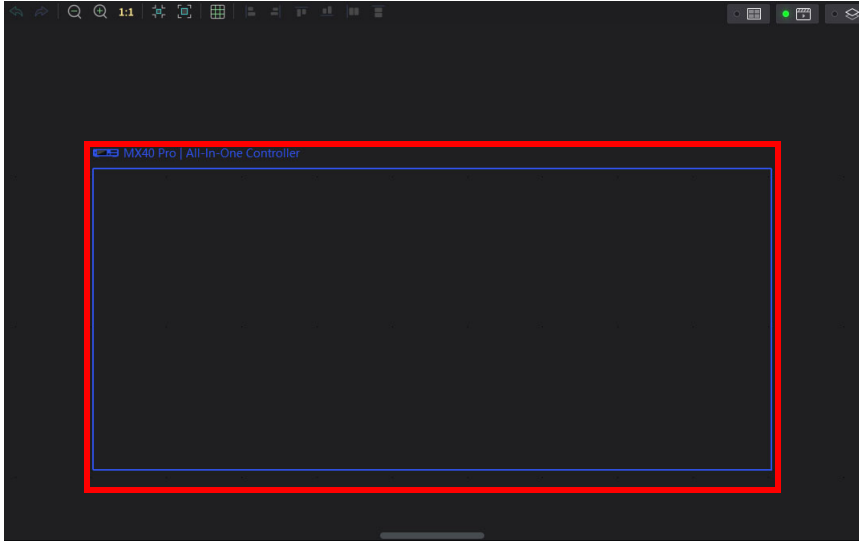

4. Select **Both** to show the source and cabinet option on the canvas.

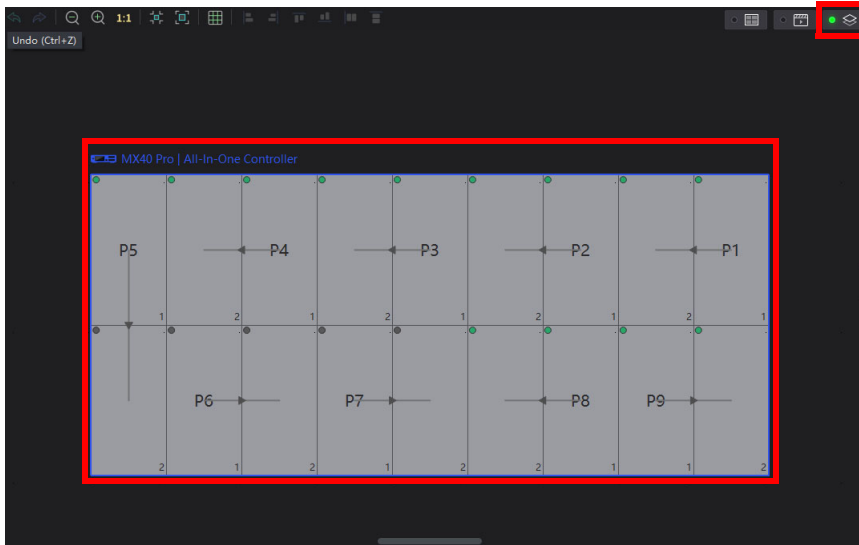

Mapping Video Panels

In order to apply various features on the NOVA VMP software, the video panels must first be mapped. To map video panels using the Nova VMP software:

1. Ensure that the **Layout** tab is selected. Locate the **Ports** window at the bottom of the display.

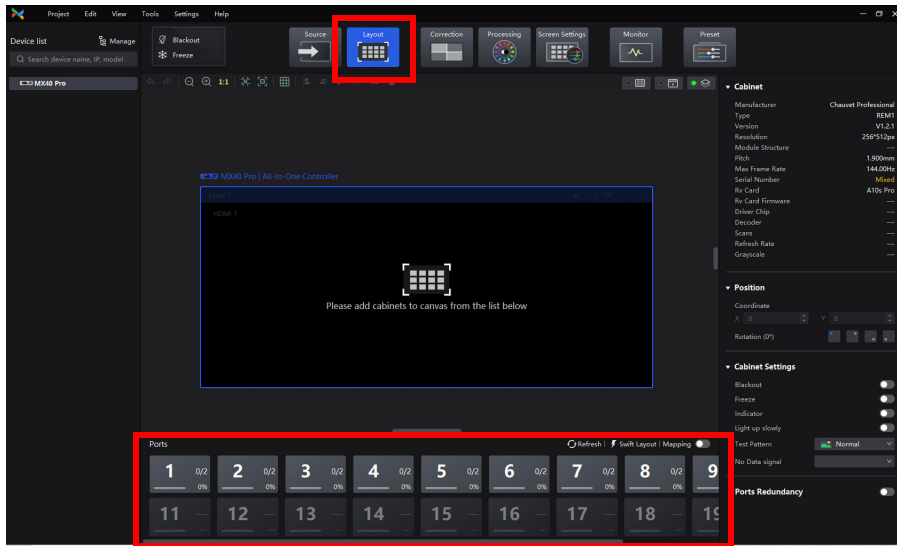

2. Select the desired port to be mapped.

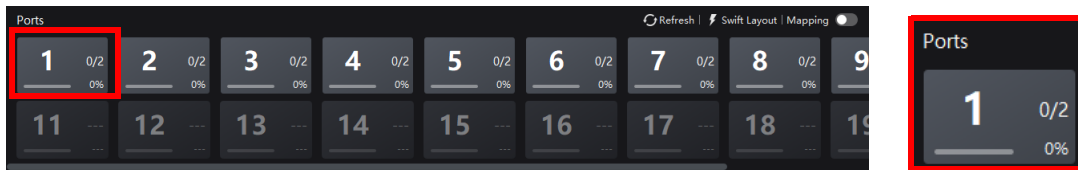

- Each port button is labeled from 1-20 and contains several values.
- The top value denotes the number of panels mapped against the number detected (i.e 0/2), and the bottom value denotes the total capacity that has been mapped (i.e 0%).

3. Drag desired panel onto the canvas.

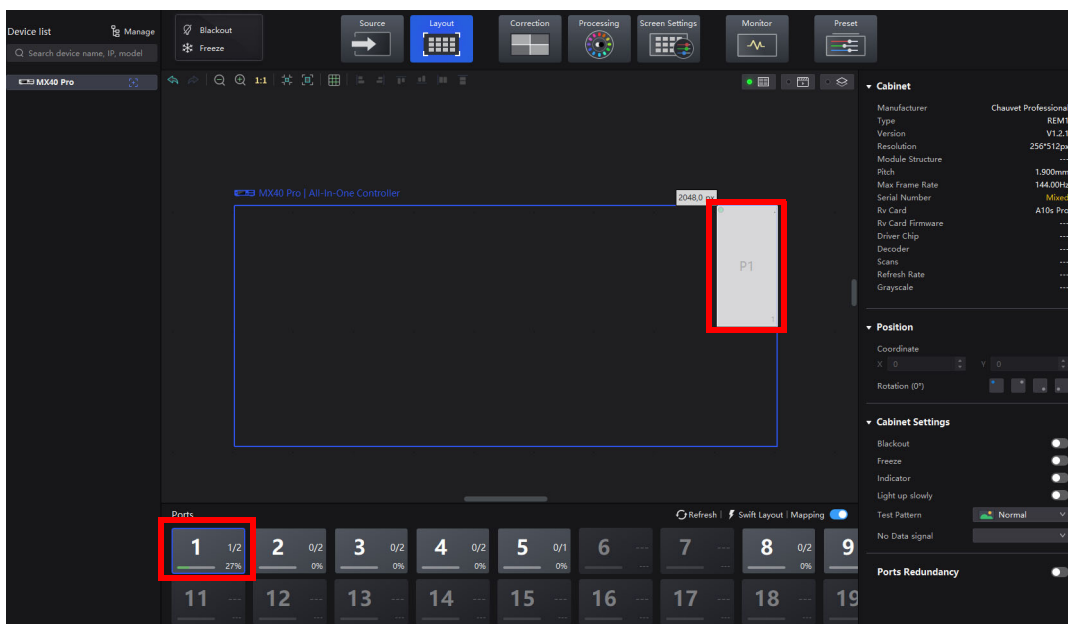

4. Press and hold to select the desired panel on the canvas. Drag the panel to map it on the canvas.

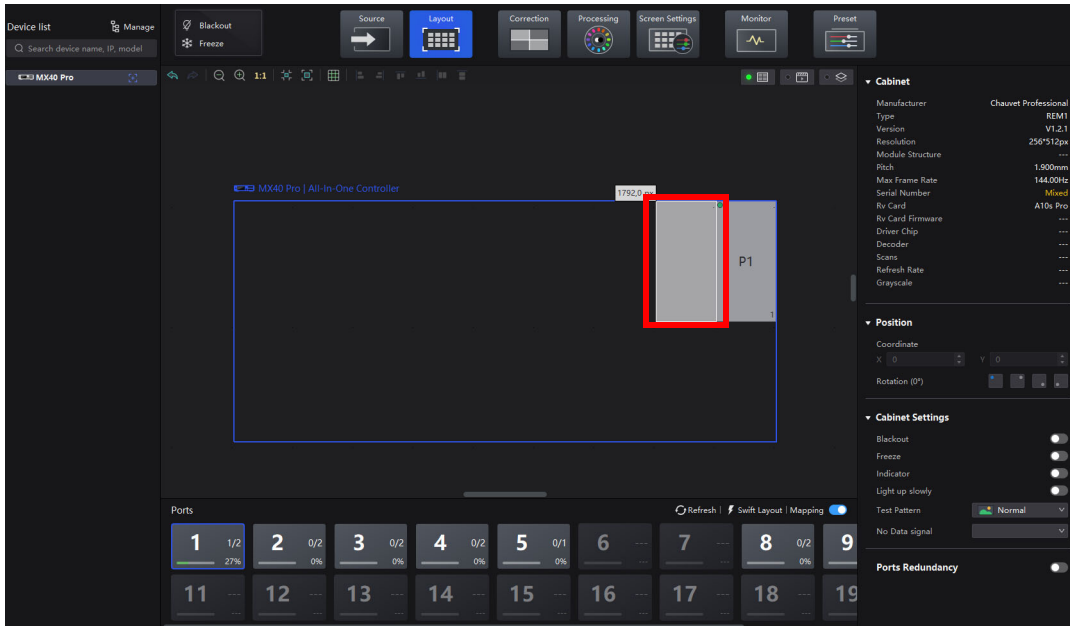

Follow the previous steps to map the entire canvas.

Changing the Video Panel Orientation

It is possible to move the REM 1 and REM 1SQ panels without manually dragging them within the canvas. To change the video panel orientation:

1. Ensure the **Layout** tab is selected. Select the panel on the canvas to be moved.

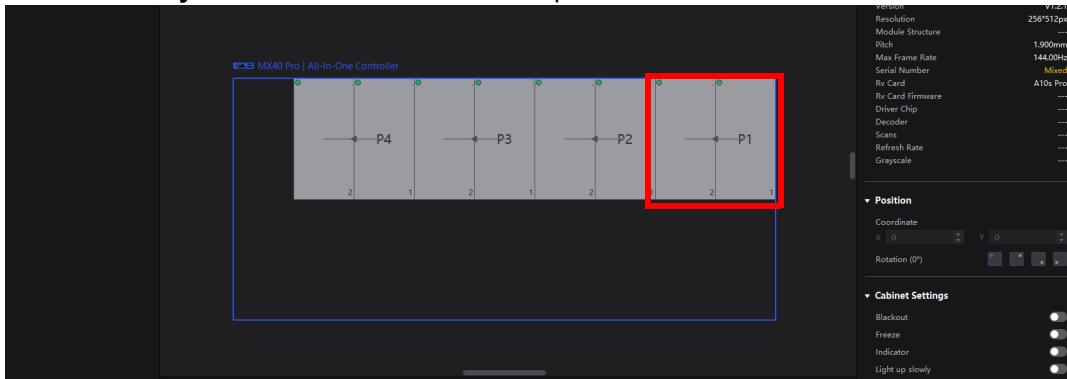

2. Open the **Position** drop down menu and locate the **Coordinate** option.

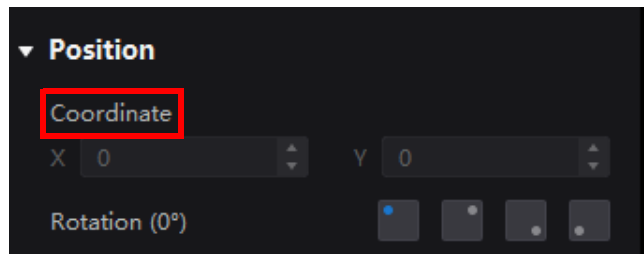

3. Under the **Coordinate** option, use the up and down arrows of the X and/or Y boxes to adjust the orientation of the panel along the x or y axis.

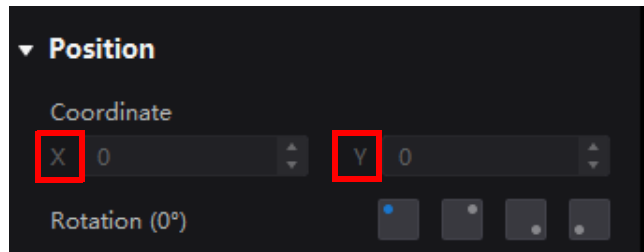

4. The changing values in the X and/or Y boxes change will move the position of the panels in the canvas.

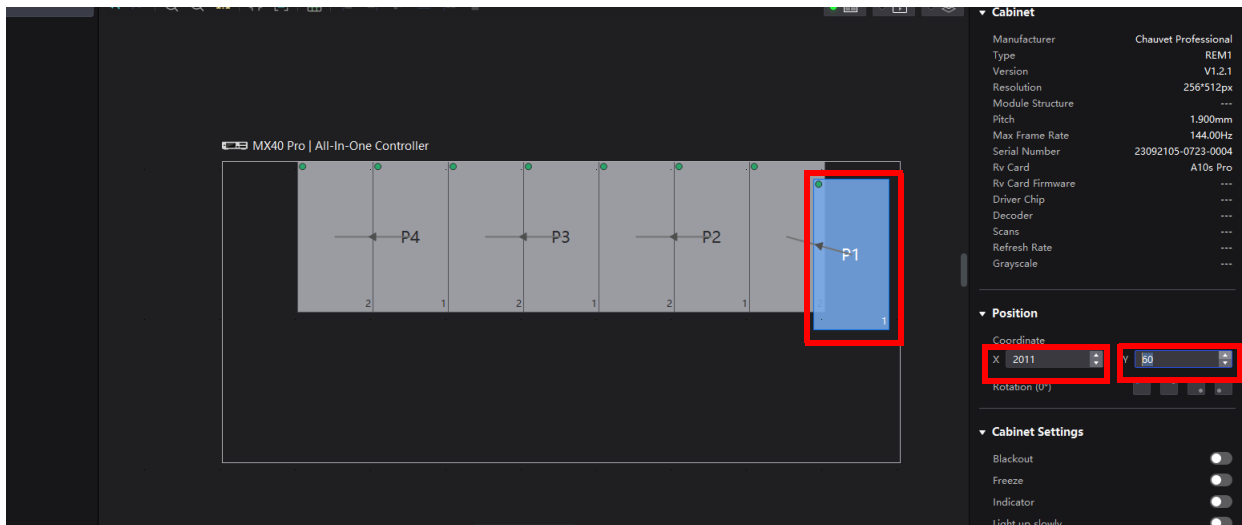

Operation

Rotating the Video Panel Orientation

When mounting REM 1 and REM 1SQ panels sideways (90° or 270°), their orientation must be set in the mapping software. To do this through Nova VMP:

1. Ensure the **Layout** tab is selected. Select the panel on the canvas to be moved.
2. Open the **Position** drop down menu and locate the **Rotation** option.

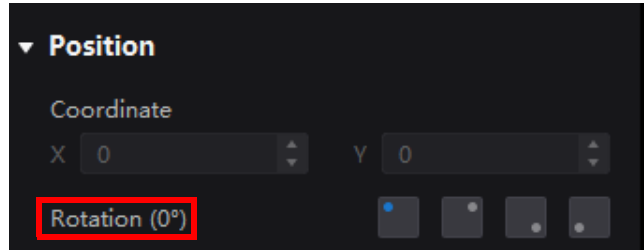

3. Next to the **Rotation** option, use the four rotate icons to adjust the panel orientation.

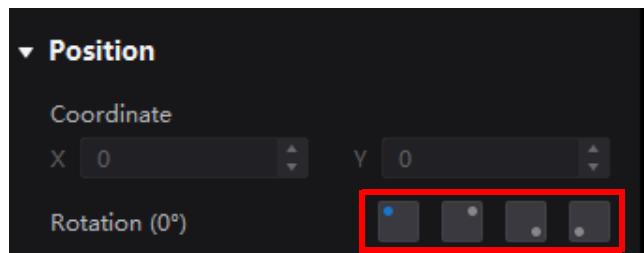

4. The panels in the canvas will rotate accordingly.

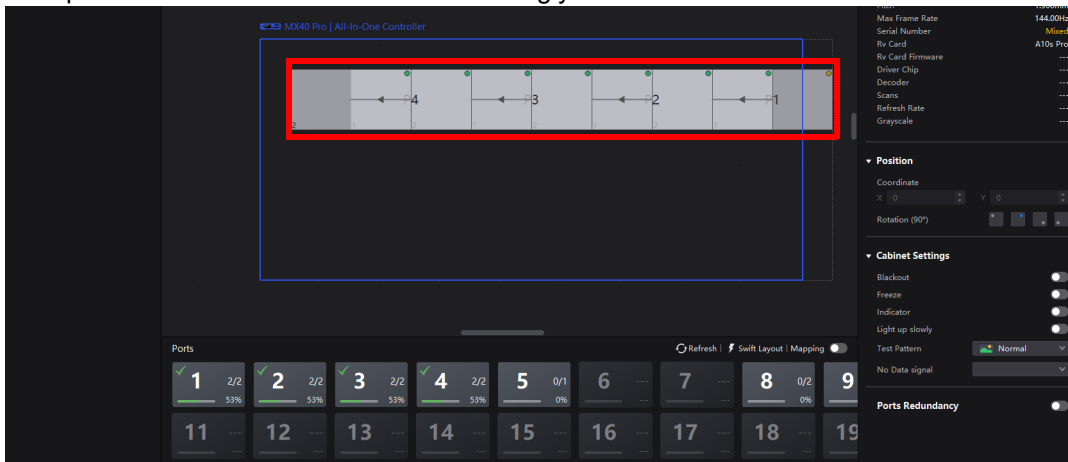

Updating Cabinet Firmware

To update the firmware of REM 1 and REM 1SQ products through VMP.

1. Select the **Tools** menu from the menu bar.

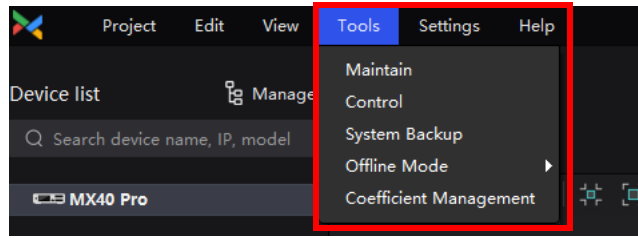

2. Select **maintain** from the **tools** menu.

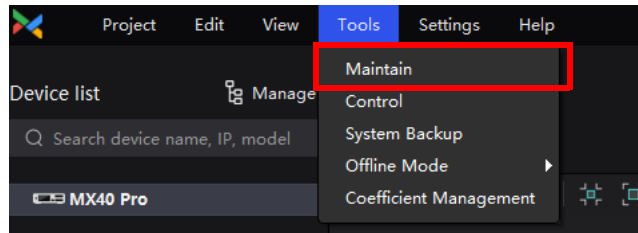

3. Under the new display, select the **cabinet** tab to provide access to the firmware installation.

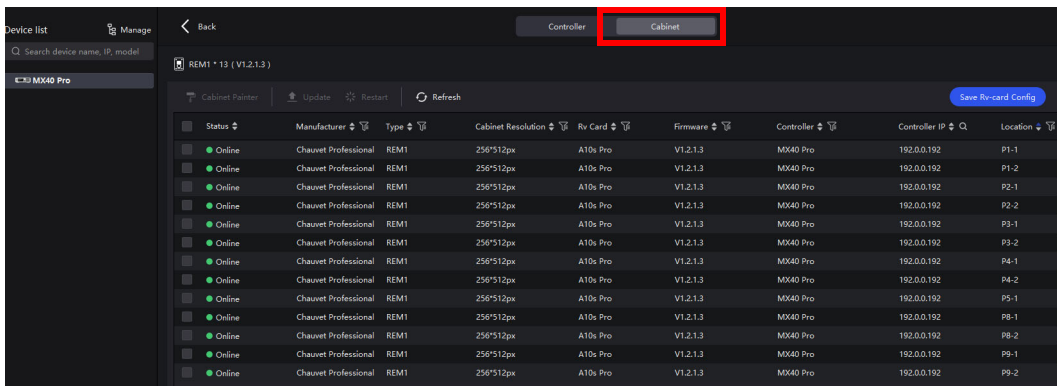

4. Select the desired update location by selecting the corresponding box(es).

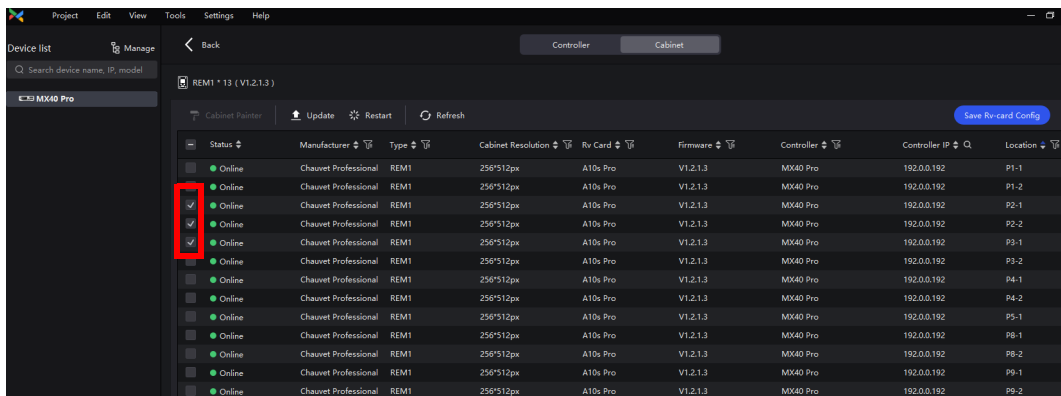

Operation

Updating Controller Firmware

To update the controller:

1. Follow steps 1-2 from the previous section.
2. Under the new display, select the **controller** tab to provide access to the firmware installation.

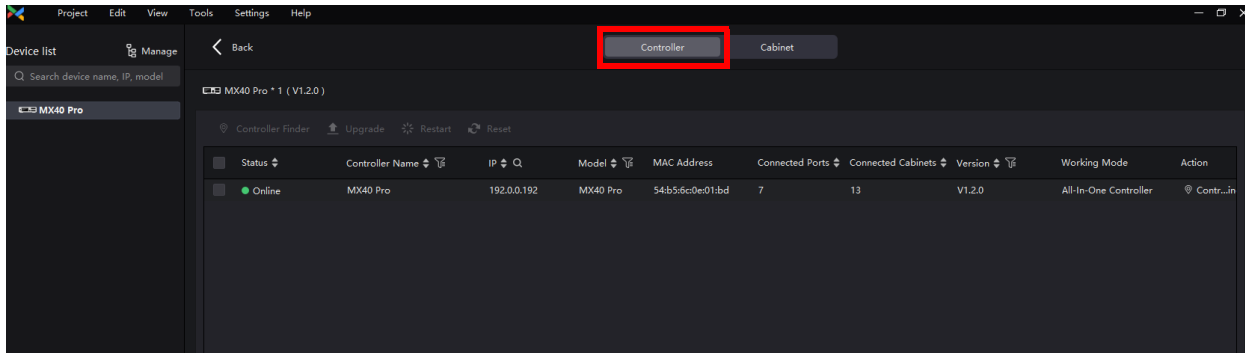

3. Select the desired update location by selecting the corresponding box(es).

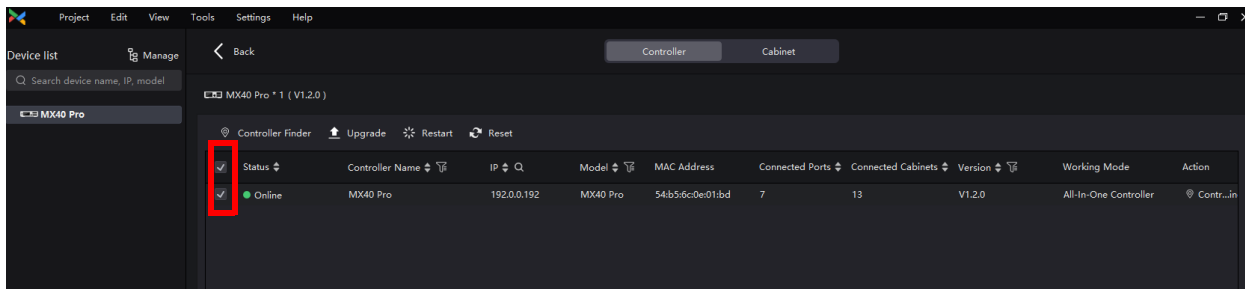

11. Technical Information

REM 1 and REM 1SQ Maintenance

To maintain optimum performance and minimize wear, the user should clean this product regularly. Usage and environment are contributing factors in determining the cleaning frequency.

As a rule, clean this product at least twice a month. Dust build-up reduces light output performance and can cause overheating. This can lead to reduced light source life and increased mechanical wear.

To clean an REM 1 and REM 1SQ, follow the recommendations below:

1. Unplug the panel from power.
2. Wait until the product is at room temperature.
3. Use a soft brush to remove dust collected on the external components.
4. Wipe the outside of the LED Modules with a soft, lint-free cloth dampened with a solution of 99% isopropyl alcohol. **ONLY** apply gentle pressure, or risk damaging the anti-reflective coating.
5. Make sure all connections are thoroughly dry before reconnecting power and signal cables.



Always dry the external surfaces carefully after cleaning them.



- **ONLY** apply gentle pressure, or risk damaging the anti-reflective coating.
- **CAUTION!** Take special care when using 99% isopropyl alcohol, as fumes may be harmful if inhaled. Vapors may cause drowsiness and dizziness. Keep away from sparks and flames.

12. Technical Specifications

REM1

| Light Source | Red Wavelength | Green Wavelength | Blue Wavelength |
|------------------------------|----------------------------|------------------------|----------------------|
| Tri-color RGB SMD 1212 LED | 620 to 625 nm | 510 to 535 nm | 458 to 475 nm |
| Pixels per Panel | Pixel Pitch (between LEDs) | Pixel Density | Display Refresh Rate |
| 256 x 512 (131,072 total) | 1.9 mm | 262,144/m ² | 3,840 Hz (S-PWM) |
| Viewing Angle (H/V) | Calibrated Illuminance | Maximum Illuminance | Contrast ratio |
| 140°/140° | 800 NITS | >1000 NITS | 6,700:1 |

Power

| Power Supply Type | AC Voltage Range | Voltage Selection | |
|-------------------|-----------------------|-------------------|---------------|
| Switching | 100–240 VAC, 50/60 Hz | Auto-ranging | |
| Parameter | 120 V, 60 Hz | 208 V, 60 Hz | 230 V, 50 Hz |
| Power Consumption | 240 W, 2.0 A | 240 W, 1.15 A | 240 W, 1.04 A |
| Power Linking | 7 units | 12 units | 14 units |

Construction/Physical

| Dimensions | Weight | |
|--|--------------------|-----------------------------------|
| 19.7 x 3.3 x 39.4 in (500 x 83 x 1000mm) | 31.2 lb (14.15 kg) | |
| Transparency | Housing Material | Operating Temperature |
| 0% | Aluminum ADC12 | -4 °F to 122 °F (-20 °C to 50 °C) |

Connections

| Power Connection | Data Connection | Control Protocol |
|--------------------------|--------------------------|------------------|
| Seetronic Powerkon® IP65 | Seetronic Etherkon® IP65 | Novastar VMP |

| Maximum Panels/Novastar MX40 Pro (HDR off, 24 Hz) | Notes for All Drives |
|---|--|
| 8-bit video source: 12/port, up to 240/Processor/Sender 10-bit video source: 9/port, up to 180/Processor/Sender 12-bit video source: 6/port, up to 120/Processor/Sender | Increasing refresh rate reduces port capacity Adding mapping space between panels reduces port capacity |
| Maximum Panels/Novastar MX40 Pro (HDR off, 30 Hz) | |
| 8-bit video source: 7/port, up to 140/Processor/Sender 10-bit video source: 7/port, up to 140/Processor/Sender 12-bit video source: 5/port, up to 100/Processor/Sender | |
| Maximum Panels/Novastar MX40 Pro (HDR off, 60 Hz) | |
| 8-bit video source: 5/port, up to 100/Processor/Sender 10-bit video source: 3/port, up to 60/Processor/Sender 12-bit video source: 2/port, up to 40/Processor/Sender | |
| Maximum Panels/Novastar MX40 Pro (HDR off, 120 Hz) | |
| 8-bit video source: 2/port, up to 40/Processor/Sender 10-bit video source: 1/port, up to 20/Processor/Sender 12-bit video source: 1/port, up to 20/Processor/Sender | |
| Maximum Panels/Novastar MX40 Pro (HDR off, 144 Hz) | |
| 8-bit video source: 2/port, up to 40/Processor/Sender 10-bit video source: 1/port, up to 20/Processor/Sender 12-bit video source: 1/port, up to 20/Processor/Sender | |

| Max. Wide/Novastar MX40 Pro | Max. Wide/Novastar MX40 Pro | Max. Wide/Novastar MX40 Pro |
|-----------------------------|-----------------------------|-----------------------------|
| 7 @ 1920 wide resolution | 15 @ 3840 wide resolution | 32 @ 8192 wide resolution |
| Max. Tall/Novastar MX40 Pro | Max. Tall/Novastar MX40 Pro | Max. Tall/Novastar MX40 Pro |
| 2 @ 1080 height | 3 @ 1344 height | 3 @ 1680 height |
| Max. Tall/Novastar MX40 Pro | Max. Tall/Novastar MX40 Pro | Max. Tall/Novastar MX40 Pro |
| 4 @ 2160 height | | |

Ordering

| Product Name | Item Name | Item Code | UPC Number |
|--------------|-----------|-----------|--------------|
| REM1 | REM1 | 23092106 | 781462224547 |

REM1SQ

| Light Source | Red Wavelength | Green Wavelength | Blue Wavelength |
|-------------------------------|----------------------------|------------------------|----------------------|
| Tri-color RGB SMD 1212 LED | 620 to 625 nm | 510 to 535 nm | 458 to 475 nm |
| Pixels per Panel | Pixel Pitch (between LEDs) | Pixel Density | Display Refresh Rate |
| 256 x 256 (131,072 total) | 1.9 mm | 262,144/m ² | 3,840 Hz (S-PWM) |
| Viewing Angle (H/V) 140°/140° | Calibrated Illuminance | Maximum Illuminance | Contrast ratio |
| | 800 NITS | >1000 NITS | 6,700: 1 |

Power

| Power Supply Type | AC Voltage Range | Voltage Selection | |
|-------------------|-----------------------|-------------------|---------------|
| Switching | 100–240 VAC, 50/60 Hz | Auto-ranging | |
| Parameter | 120 V, 60 Hz | 208 V, 60 Hz | 230 V, 50 Hz |
| Power Consumption | 120 W, 1.0 A | 120 W, 0.57 A | 120 W, 0.52 A |
| Power Linking | 15 units | 25 units | 28 units |

Construction/Physical

| Dimensions | Weight | |
|---|-------------------|-----------------------------------|
| 19.7 x 3.3 x 19.7 in (500 x 83 x 500mm) | 18.2 lb (8.26 kg) | |
| Transparency | Housing Material | Operating Temperature |
| 0% | Aluminum ADC12 | -4 °F to 122 °F (-20 °C to 50 °C) |

Connections

| Power Connection | Data Connection | Control Protocol |
|--------------------------|--------------------------|-------------------|
| Seetronic Powerkon® IP65 | Seetronic Etherkon® IP65 | Novastar Coex VMP |

| Maximum Panels/Novastar MX40 Pro (HDR off, 24 Hz) | Notes for All Drives | | |
|---|--|-----------------------------|-----------------|
| 8-bit video source: 25/port, up to 500/Processor/Sender 10-bit video source: 18/port, up to 360/Processor/Sender 12-bit video source: 12/port, up to 240/Processor/Sender | Increasing refresh rate reduces port capacity Adding mapping space between panels reduces port capacity | | |
| Maximum Panels/Novastar MX40 Pro (HDR off, 30 Hz) | | | |
| 8-bit video source: 20/port, up to 400/Processor/Sender 10-bit video source: 15/port, up to 300/Processor/Sender 12-bit video source: 10/port, up to 200/Processor/Sender | | | |
| Maximum Panels/Novastar MX40 Pro (HDR off, 60 Hz) | | | |
| 8-bit video source: 10/port, up to 200/Processor/Sender 10-bit video source: 7/port, up to 140/Processor/Sender 12-bit video source: 5/port, up to 100/Processor/Sender | | | |
| Maximum Panels/Novastar MX40 Pro (HDR off, 120 Hz) | | | |
| 8-bit video source: 5/port, up to 100/Processor/Sender 10-bit video source: 3/port, up to 60/Processor/Sender 12-bit video source: 2/port, up to 40/Processor/Sender | | | |
| Maximum Panels/Novastar MX40 Pro (HDR off, 144 Hz) | | | |
| 8-bit video source: 4/port, up to 80/Processor/Sender 10-bit video source: 3/port, up to 60/Processor/Sender 12-bit video source: 2/port, up to 40/Processor/Sender | | | |
| Max. Wide/Novastar MX40 Pro | Max. Wide/Novastar MX40 Pro | Max. Wide/Novastar MX40 Pro | |
| 7 @ 1920 wide resolution | 15 @ 3840 wide resolution | 32 @ 8192 wide resolution | |
| Max. Tall/Drive | Max. Tall/Drive | Max. Tall/Drive | Max. Tall/Drive |
| 4 @ 2160 height | 5 @ 1344 height | 6 @ 1680 height | 8 @ 2160 height |

Ordering

| Product Name | Item Name | Item Code | UPC Number |
|--------------|-----------|-----------|--------------|
| REM 1SQ | REM1SQ | 23092108 | 781462224561 |

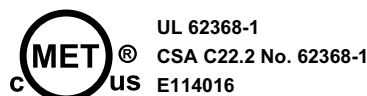

RoHS



Contact Us

| General Information | Technical Support |
|---|--|
| Chauvet World Headquarters | |
| Address: 3360 Davie Rd., Suite 509 Davie, FL 33314 Voice: (954) 577-4455 Fax: (954) 929-5560 Toll Free: (800) 762-1084 | Voice: (844) 393-7575 Fax: (954) 756-8015 Email: chauvetcs@chauvetlighting.com Website: www.chauvetprofessional.com |
| Chauvet Europe Ltd | |
| Address: Pod 1 EVO Park Little Oak Drive Sherwood Park, Nottinghamshire, U.K. NG15 OEB Voice: +44 (0) 1773 511115 Fax: +44 (0) 1773 511110 | Email: UKtech@chauvetlighting.eu Website: www.chauvetprofessional.eu |
| Chauvet Europe BVBA | |
| Address: Stokstraat 18 9770 Kruishoutem Belgium Voice: +32 9 388 93 97 | Email: BNLtech@chauvetlighting.eu Website: www.chauvetprofessional.eu |
| Chauvet France | |
| Address: 3, Rue Ampère 91380 Chilly-Mazarin France Voice: +33 1 78 85 33 59 | Email: FRtech@chauvetlighting.fr Website: www.chauvetprofessional.eu |
| Chauvet Germany | |
| Address: Bruno-Bürgel-Str. 11 28759 Bremen Germany Voice: +49 421 62 60 20 | Email: DEtech@chauvetlighting.de Website: www.chauvetprofessional.eu |
| Chauvet Mexico | |
| Address: Av. de las Partidas 34 - 3B (Entrance by Calle 2) Zona Industrial Lerma Lerma, Edo. de México, CP 52000 Voice: +52 (728) 690-2010 | Email: servicio@chauvet.com.mx Website: www.chauvetprofessional.mx |

Warranty & Returns

For warranty terms and conditions and return information, please visit our website.

For customers in the United States and Mexico: www.chauvetlighting.com/warranty-registration.

For customers in the United Kingdom, Republic of Ireland, Belgium, the Netherlands, Luxembourg, France, and Germany: www.chauvetlighting.eu/warranty-registration.